

2 Safety

2.1 Principle

State of the art

This machine has been constructed with state-of-the-art technology according to the recognized rules of safety. Nevertheless, when used improperly, dangers to the life and limb of the operator or to third persons or damage to the machine or other materials cannot be excluded.

Proper use

The machine must only be used for the following purposes:

- Compaction of soils.
- Compaction of asphalt.
- Shaking in of paving stones.

The machine may not be used for the following purposes:

- Compaction of intensely cohesive soils.
- Compaction of frozen soils.
- Compaction of hard, non-compactable soils.
- Compaction of soils that are not capable of bearing a load.

Its proper use also includes the observance of all instructions contained in this operator's manual as well as complying with the required service and maintenance instructions.

Any other use is regarded as improper. Any damage resulting from improper use will void the warranty and the liability on behalf of the manufacturer. The operator assumes full responsibility.

Structural modifications

Never attempt to modify the machine without the written permission of the manufacturer. To do so will endanger your safety and the safety of other people! In addition, this will void the warranty and the liability on behalf of the manufacturer.

Especially the following are cases of structural modifications:

- Opening the machine and the permanent removal of components from Wacker Neuson.
- Installing new components which are not from Wacker Neuson and not equivalent to the original parts in design and quality.
- Installation of accessories which are not from Wacker Neuson.

It is no problem to install spare parts from Wacker Neuson.

It is no problem to install accessories that are available in the Wacker Neuson product range of your machine. Please refer to the installation regulations in this operator's manual.

Requirements for operation

The ability to operate the machine safely requires:

- Proper transport, storage and setup.
- Careful operation.
- Careful service and maintenance.

Operation

Operate the machine only as intended and only when in proper working condition.

Operate the machine in a safety-conscious manner with all safety devices attached and enabled. Do not modify or disable any safety devices.

Before starting operation, check that all control and safety devices are functioning properly.

Never operate the machine in a potentially explosive environment.

Supervision

Never leave the machine running unattended!

Maintenance

Regular maintenance work is required in order for the machine to operate properly and reliably over time. Failure to perform adequate maintenance reduces the safety of the machine.

- Strictly observe the prescribed maintenance intervals.
- Do not use the machine if it requires maintenance or repairs.

Malfunctions

If you detect a malfunction, you must shut down and secure the machine immediately.

Eliminate the malfunctions that impair safety immediately!

Have damaged or defective components replaced immediately!

For further information, refer to chapter *Troubleshooting*.

Spare parts, accessories

Use only spare parts from Wacker Neuson or such that are equivalent to the original parts in design and quality.

Only use accessories from Wacker Neuson.

Non-compliance will exempt the manufacturer from all liability.

Exclusion of liability

Wacker Neuson will refuse to accept liability for injuries to persons or for damage to materials in the following cases:

- Structural modifications.
- Improper use.
- Failure to comply with this operator's manual.
- Improper handling.
- Using of spare parts which are not from Wacker Neuson and not equivalent to the original parts in design and quality.
- Using of accessories which are not from Wacker Neuson.

Operator's manual

Always keep the operator's manual near the machine or near the worksite for quick reference.

If you have misplaced the operator's manual or require an additional copy, contact your Wacker Neuson representative or download the operator's manual from the Internet (www.wackerneuson.com).

Always hand over this operator's manual to other operators or to the future owner of the machine.

Country-specific regulations

Observe the country-specific regulations, standards and guidelines in reference to accident prevention and environmental safety, for example those pertaining to hazardous materials and wearing protective gear.

Complement the operator's manual with additional instructions taking into account the operational, regulatory, national or generally applicable safety guidelines.

Operator's controls

Always keep the operator's controls of the machine dry, clean and free of oil or grease.

Operating elements such as ON/OFF switch, gas handles etc. may not be locked, manipulated or changed without authorization.

Cleaning

Always keep the machine clean and be sure to clean it each time you have finished using it.

Do not use gasoline or solvents. Danger of explosion!

Do not use high pressure washers. Permeating water can damage the machine. When electrical equipment is present, this can pose a serious injury risk from electric shocks.

Checking for signs of damage

Inspect the machine when it is switched off for any signs of damage at least once per work shift.

Do not operate the machine if there is visible damage or defects.

Have any damage or defects eliminated immediately.

2.2 Qualification of the operating personnel**Operator qualifications**

Only trained personnel are permitted to start and operate the machine. The following rules also apply:

- You are at least 18 years of age.
- You are physically and mentally fit.
- You have received instruction on how to independently operate the machine.
- You have received instruction in the proper use of the machine.
- You are familiar with required safety devices.
- You are authorized to start machines and systems in accordance with the standards governing safety.
- Your company or the operator has assigned you to work independently with this machine.

Incorrect operation

Incorrect operation or misuse by untrained personnel can endanger the health and safety of the operator or third persons and also cause machine and material damage.

Operating company responsibilities

The operating company must make the operator's manual available to the operator and ensure that the operator has read and understood it.

Work recommendations

Please observe the recommendations below:

- Work only if you are in a good physical condition.
- Work attentively, particularly as you finish.
- Do not operate the machine when you are tired.
- Carry out all work calmly, circumspectly and carefully.
- Never operate the machine under the influence of alcohol, drugs or medication. This can impair your vision, reactions and your judgment.
- Work in a manner that does not endanger others.
- Ensure that no persons or animals are within the danger zone.

2.3 Protective gear

Work clothing

Clothing should be appropriate, i.e. should be close-fitting but not restrict your movement.

When on construction sites, do not wear long hair loosely, loose clothing or jewelry including rings. These objects can easily get caught or be drawn in by moving machine parts.

Only wear clothing made of material that is not easily flammable.

Personal protective gear

Wear personal protective gear to avoid injuries or health hazards:

- Non-skid, hard-toed shoes.
- Work gloves made of durable material.
- Overalls made of durable material.
- Hard hat.
- Ear protection.

Ear protection

This machine generates noise that exceeds the country-specific permissible noise levels (individual rating level). It may therefore be necessary to wear ear protection. You can find the exact value in the chapter *Technical Data*.

When wearing ear protection while working, you must pay attention and exercise caution because your hearing is limited, e.g. in case someone screams or a signal tone sounds.

Wacker Neuson recommends that you always wear ear protection.

2.4 Transport

Switching off the machine

Before you transport the machine, it must be switched off, and the engine must be given sufficient time to cool down.

Center pole in transport position

Before commencing transport, move the center pole to the transport position. Let the center pole latch into its lock.

Observing hazardous materials regulations

Observe the national safety guidelines and the hazardous materials regulations that apply to the respective means of transportation.

Lifting

When lifting the machine, observe the following instructions:

- Designate a skilled person to guide you for the lifting procedure.
- You must be able to see or hear this person.
- Use only suitable and certified hoisting gear, lifting tackle and load-bearing equipment with sufficient lifting capacities.
- Only use the attachment points described in the operator's manual.
- Attach the machine securely to the hoisting gear.
- Ensure that no one is nearby or under the machine.
- Do not climb onto the machine.

Loading the machine

Loading ramps must be able to bear the load and be in a stable position.

Make sure that no one can be endangered if the machine slips away or tips over or if machine parts suddenly move upward or downward.

Put the operating controls and moving parts in their transport position.

Secure the machine with load-securing straps so that it cannot tip over, fall down or slide away. Only use the attachment points described in the operator's manual.

Transport vehicle

Use only suitable transport vehicles with sufficient load-carrying capacity and suitable tie-down lugs.

Transporting the machine

Secure the machine on the transport device against tilting, falling or slipping.

Only use the lashing points listed in the operating instructions.

Also observe the country-specific regulations, standards and guidelines.

Restarting

Machines, machine parts, accessories or tools that were detached for transport purposes must be re-mounted and fastened before restarting.

Only operate in accordance with the operating instructions.

2.5 Operating safety

Explosible environment

Never operate the machine in a potentially explosive environment.

Work environment

Familiarize yourself with your work environment before you start work. This includes e.g. the following items:

- Obstacles in the work and traffic area.
- Load-bearing capacity of the ground.
- The measures needed to cordon off the construction site from public traffic in particular.
- The measures needed to secure walls and ceilings.
- Options available in the event of an accident.

Safety in the work area

When working with the machine especially pay attention to the following points:

- Electric lines or pipes in work area.
- Gas lines or water lines in the work area.

Starting the machine

Observe the safety information and warning notices located on the machine and in the operator's manual.

Never attempt to start a machine that requires maintenance or repairs.

Start the machine as directed in the operator's manual.

Vertical stability

Always ensure that the machine is vertically stable and cannot tip over, roll or slide away.

Proper operator position

Do not leave the proper operator position while operating the machine.

The proper operator position is behind the center pole of the machine.

Leaving the danger area

Injury may be caused by moving machines or flying materials.

Ensure that other persons observe a minimum safety distance of 2 m from the machine.

Caution with movable parts

Keep your hands, feet and loose clothing away from moving or rotating machine parts. Parts of your body being pulled in or crushed can cause serious injuries.

Switching off the machine

Switch off the engine in the following situations:

- Before breaks.
- If you are not using the machine.

Store the machine in such a way that it cannot tilt, fall or slip.

Storage location

After operation, allow the machine to cool and then store it in a sealed-off, clean and dry location protected against frost and inaccessible to children.

Not using starter sprays

Highly flammable starter sprays pose a fire hazard.

Do not use any starter sprays.

Starter sprays are highly flammable and can cause backfiring and engine damage.

Vibrations

When manually operated machines are intensively used, long-term damage caused by vibrations cannot be precluded.

Observe the relevant legal instructions and guidelines to minimize vibration stress.

Details on vibration stress associated with the machine can be found in the chapter *Technical Data*.

2.6 Safety during the operation of vibratory plates**Integrated driving mechanism**

Machines with integrated driving mechanism must not be set down or stored on the transport device. The driving mechanism is only intended for transport.

Belt guard

Never operate the machine without a belt guard!

Exposed belts and belt pulleys are dangerous and can cause serious injuries if they pull in any part of your body or if parts are ejected.

Danger of falling over

Operate the machine so that it cannot tip over or fall down from bordered areas, edges and steps.

Load-carrying capacity of the ground

Keep in mind that the load-carrying capacity of the earth to be compressed or bed can be greatly reduced by the effects of vibration, for example near slopes.

Avoiding crushing

When operating the machine, pay particular attention to avoid being squeezed between the machine and an obstacle. Always look in the direction of travel!

Compacting on slopes

The following points must be observed if you plan to compact inclined surfaces (slopes, escarpments):

- Always stand above the machine on a slope.
- Start at the bottom of a slope (slopes that can be easily managed in an upward direction can be safely traveled in a downward direction also).
- Never stand in a position where the machine could possibly fall. A slipping or tipping machine can cause serious injuries.

Not exceeding the maximum tilt position

- Do not exceed the maximum tilt position (see chapter *Technical Data*).
- Only operate the machine at maximum tilt for short periods of time.

If you exceed the maximum tilt, the engine lubrication system will fail and thus inevitably damage important engine parts.

Check the effects of vibration

Compacting work in the vicinity of buildings can lead to structural damage. For this reason you must always check the possible effects of vibrations on surrounding buildings in the run-up to work.

You must take the following points into special consideration when evaluating the effects of vibration:

- Vibration behavior, sensitivity and resonance frequency of surrounding buildings.
- Distance of the buildings from the vibrationsite (= worksite).
- Condition of the soil.

You may need to carry out measurements to determine the vibration speed.

You must also comply with the relevant guidelines and regulations, particularly DIN 4150-3.

The foundation must also have sufficient load-bearing capacity to withstand the compaction energy. In case of doubt involve a soil mechanics specialist in the evaluation.

Wacker Neuson is not liable for any structural damage.

2.7 Safety during the operation of combustion engines

Checking for signs of damage

Check the engine while switched off for leaks and cracks in the fuel line, tank and fuel cap at least once per work shift.

Do not operate the machine if there is visible damage or defects.

Have any damage or defects eliminated immediately.

Dangers during operation

Combustion engines can be dangerous, particularly during operation and when refueling.

Read and follow all safety instructions. Otherwise there is a risk of personal injury and/or damage to property!

Do not start the engine near spilt fuel or if you smell fuel – this may cause an explosion!

- Remove the machine from such areas.
- Remove the spilt fuel immediately!

Not changing the engine speed

Do not change the preset engine speed, as this may cause engine damage.

Preventing fires

Open flames and smoking are strictly prohibited in the immediate vicinity of the machine.

Make sure that waste, such as paper, dry leaves or grass do not accumulate around the exhaust muffler. The waste materials may ignite.

Safety precautions when refueling

Please observe the following safety-relevant instructions when refueling:

- Do not refuel near open flames.
- Do not smoke.
- Turn off the engine before refueling and allow it to cool down.
- Refuel in a well-ventilated environment.
- Wear fuel-proof protective gloves and, if there is the possibility of spraying, protective goggles and clothing.
- Do not inhale fuel vapors.
- Avoid skin and eye contact with fuel.
- For refueling, use clean tools such as a hopper.
- Do not spill fuel, especially onto hot parts.
- Remove any spilt fuel immediately.
- Use the correct fuel grade.
- Do not mix fuel with other liquids.
- Fill the tank only up to the maximum marking. If there is no Maximum marking, do not fill up the tank completely.
- Lock the fuel cap securely after refueling.

Operation in closed rooms

In closed or partially closed rooms such as tunnels, drifts or deep trenches, ensure sufficient ventilation and extraction by, for example, providing a powerful exhaust air fan.

Danger of poisoning! Do not inhale exhaust fumes. They contain toxic carbon monoxide that can lead to unconsciousness or death.

Caution with hot parts

Do not touch any hot parts such as the engine block or exhaust muffler during operation or directly afterwards. These parts can become very hot and cause severe burns.

Cleaning the engine

Clean the engine when it is cool to remove any dirt.

Do not use gasoline or solvents. Danger of explosion!

Notes on the EPA engine

Caution

This machine is equipped with an EPA-certified engine.

Modifying the motor speed influences the EPA certification and emission. The motor may only be set by a skilled technician.

For more detailed information, contact your nearest motor or Wacker Neuson representative.

Health hazard due to exhaust fumes

Warning

The engine's exhaust fumes contain chemicals which are known to the State of California to cause cancer, congenital defects or other reproductive anomalies.

2.8 Safety during the operation of hydraulic machines**Hydraulic oil**

Hydraulic oil is harmful to health.

Wear safety glasses and safety gloves when handling hydraulic oil.

Avoid direct skin contact with hydraulic oil. Remove hydraulic oil from the skin immediately with soap and water.

Make sure that no hydraulic oil comes gets in the eyes or on the body. See a physician immediately if hydraulic oil gets into the eyes or is swallowed.

Do not eat and drink while handling hydraulic oil.

Make sure to have extreme cleanliness. Contamination of the hydraulic oil with dirt or water can cause premature wear or failure of the machine.

Dispose of left over and spilled hydraulic oil according to the applicable regulations for environmental protection.

2.9 Maintenance**Maintenance work**

Service and maintenance work must only be carried out to the extent described in these operating instructions. All other procedures must be performed by your Wacker Neuson representative.

For further information, refer to chapter *Maintenance*.

Switching off the engine

Before carrying out care or maintenance work, switch off the engine and allow it to cool down.

For gasoline powered engines, you must pull off the spark plug cap.

Disconnecting the battery

For machines with electric starter, you must disconnect the battery before working on the electronic parts.

Using only a Wacker Neuson battery

Use only Wacker Neuson batteries to replace defective batteries, see chapter *Technical Data*.

Only the Wacker Neuson battery is vibration resistant and thus suitable for the high vibratory stresses.

Working on the battery

Always take the following safety measures when working with the battery:

- No fire, sparks, or smoking while working with batteries.
- Batteries contain corrosive acid. Use acid-proof protective gloves and protective goggles when working with batteries.
- Avoid short circuits due to improper connection or bypassing with tools.
- Disconnect the negative terminal first when disconnecting the battery.
- Connect the positive terminal first when connecting the battery.
- Re-fasten terminal covers after connecting the battery.

Assembling safety devices

If it was necessary to dismantle safety devices, they must be reassembled and checked immediately after completing maintenance work.

Always tighten loosened screw connections, complying with prescribed starting torque.

Handling operating fluids safely

Observe the following points when handling operating fluids, e.g. fuels, oils, greases, coolants etc.:

- Always wear personal safety clothing.
- Avoid skin and eye contact with operating fluids.
- Do not inhale or swallow operating fluids.
- In particular, avoid contact with hot operating fluids. Burn and scalding hazard.
- Dispose of replaced or spilled operating fluids according to the applicable regulations for environmental protection.
- If operating fluids escape from the machine, cease operation of the machine and have it repaired immediately by your Wacker Neuson representative.





2.10 Safety and information labels

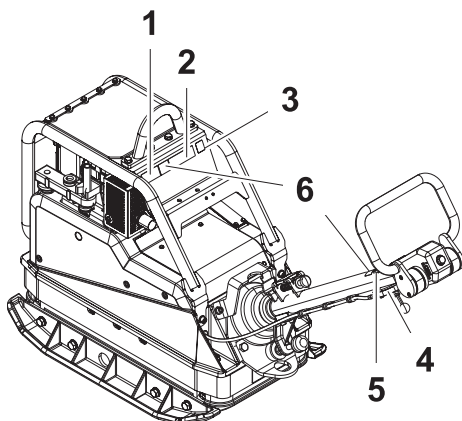

Your machine has adhesive labels containing the most important instructions and safety information.

- Make sure that all the labels are kept legible.
- Replace any missing or illegible labels.

The item numbers for the labels are in the parts book.



Pos.	Label	Description
1		Wear personal protective gear to avoid injuries or health hazards: <ul style="list-style-type: none"> ■ Ear protection. Read the operator's manual before start-up.
2		If the machine falls, it can cause severe crushing injuries. <ul style="list-style-type: none"> ▶ Only lift the machine with certified hoist and lifting tackle (safety load hook). ▶ Do not lift the machine with the excavator shovel by the central suspension. ▶ Do not lift the machine with a forklift by the central suspension.
3		Guaranteed sound power level.
4		Start-Stop.

Pos.	Label	Description
5		If the machine falls, it can cause severe crushing injuries. ▶ Do not lift the machine by the guide handle or the center pole.
6	US machines 	Warning