

# Instruction manual

Operating & Maintenance  
4812163001\_C.pdf

Vibratory rollers  
CC1100 VI / CC1200 VI

## Engine

Kubota D1703-M-DI-E4B (T4f) (18.5 kW)  
Kubota D1703-M-IDI-E3 (III A/T3) (26 kW)  
Kubota D1803-CR (T4f) (28 kW)  
Kubota D1703-M-DI-E4B (Stage V) (18.5 kW)  
Kubota D1803-CR-E5B (Stage V) (28 kW)

## Serial number

10000390xxA021827 - xA023287	10000396xxA018676 - xA023341
10000389xxA018679 -	10000395xxA018609 -
10000391xxA021487 -	10000397xxA018677 -
10000444xxA024596 -	10000446xxA023389 -
10000452xxA0**** -	10000454xxA0**** -



Translation of original instruction

Reservation for changes  
Printed in Sweden







## Table of Contents

Introduction .....	1
The machine .....	1
Intended use .....	1
Warning symbols.....	1
Safety information .....	1
General .....	2
CE marking and Declaration of conformity.....	3
Safety - General instructions.....	5
Safety - when operating .....	7
Work driving .....	7
Driving near edges .....	8
Safety (Optional) .....	9
Edge cutter/compactor .....	9
Chip spreader.....	9
Special instructions .....	11
Standard lubricants and other recommended oils and fluids .....	11
Higher ambient temperatures, above +40°C (104°F).....	11
Lower ambient temperature - Freeze risk .....	11
Temperatures.....	11
High pressure cleaning .....	11
Fire fighting .....	12
Roll Over Protective Structure (ROPS) .....	12
Battery handling .....	12
Jump starting.....	13
Technical specifications .....	15
Vibrations - Operator station .....	15
Noise level.....	15
Dimensions, top view .....	16
Dimensions, side view.....	17
Weights and volumes.....	18

Working capacity .....	18
General .....	19
CO <sub>2</sub> -emission .....	19
Tightening torque .....	20
ROPS - bolts .....	21
Hydraulic system .....	21
Slopes .....	21
Machine description .....	23
Diesel engine .....	23
Electrical system .....	23
Propulsion system/Transmission .....	23
Brake system .....	23
Steering system .....	23
ROPS .....	23
Identification .....	24
Product and component plates .....	24
Product identification number on the frame .....	24
Explanation of 17PIN serial number .....	25
Machine plate .....	25
Engine plates .....	26
Location - decals .....	28
Location - decals, CALIFORNIA .....	29
Safety decals .....	29
Info decals .....	33
Instruments/Controls .....	34
Locations - Control panel and controls .....	34
Functional description - Membrane panel .....	35
Function description - Display .....	35
Display explanations .....	37
Transport mode .....	38

Working mode, Vibration .....	39
Working mode - Edge cutter .....	41
Working mode - Chip spreader .....	42
Function description, buttons on Forward/Reverse lever .....	43
Function description - Regeneration .....	44
Sub-menu - Regeneration (only D1803 T4f, T5 (28 kW)) .....	45
Sub-menu - Alarm .....	45
User settings .....	47
Function description - Alarm .....	48
Electrical system .....	49
Fuses .....	49
Fuses at battery master disconnect switch .....	50
Relays on machine .....	51
Operation .....	53
Before starting .....	53
Master switch - Switching on .....	53
Driver seat - Adjustment .....	54
Parking brake - Check .....	55
Reserve brake - Control .....	56
Instruments and lamps - Checking .....	56
Interlock .....	57
Operator position .....	57
Adjusting the Off-set .....	58
Flow divider (Optional) .....	58
Starting .....	59
Starting the engine .....	59
D1703 .....	59
D1803 .....	59
Driving .....	61

Operating the roller .....	61
D1703 .....	61
D1803 .....	61
Interlock/Emergency stop/Parking brake - Check .....	62
Edge cutting (Optional) .....	63
Vibration .....	64
Manual/Automatic vibration .....	64
Braking .....	65
Normal braking .....	65
Emergency braking .....	65
Switching off .....	66
D1703 .....	66
D1803 .....	66
Parking .....	67
Chocking the drums .....	67
Battery disconnecter .....	67
Long-term parking .....	69
Engine .....	69
Battery .....	69
Air cleaner, exhaust pipe .....	69
Fuel tank .....	69
Hydraulic reservoir .....	69
Steering cylinder, hinges, etc. ....	70
Watering system .....	70
Hoods, tarpaulin .....	70
Miscellaneous .....	71
Lifting .....	71
Locking the articulation .....	71
Lifting the roller .....	72
Lifting the roller with a single -point lift (Optional) .....	73

---

Unlocking the articulation .....	74
Towing/Recovering .....	74
Release the brakes .....	75
Short distance towing with switched off engine.....	76
Towing the roller.....	77
Transport .....	78
Securing CC1100 VI / CC1200 VI for loading .....	79
Securing CC1100 VI / CC1200 VI for loading (Side across the trailer).....	81
Securing CC1100 VI / CC1200 VI for loading (Side along the trailer).....	83
Foldable ROPS .....	85
Operating instructions - Summary .....	87
Preventive maintenance .....	89
Acceptance and delivery inspection.....	89
Warranty.....	89
Maintenance - Lubricants and symbols .....	91
Maintenance symbols .....	93
Maintenance - Maintenance schedule .....	95
Service and maintenance points .....	95
General .....	96
Every 10 hours of operation (Daily).....	96
After the FIRST 50 hours of operation .....	97
Every 50 hours of operation (Weekly).....	97
Every 250 / 750 / 1250 / 1750 hours of operation .....	97
Every 500 hours of operation .....	98
Every 1000 hours of operation .....	99
Every 1500 hours of operation (only T4, T5 (28 kW)) .....	99
Every 2000 hours of operation .....	100
Every 3000 hours of operation .....	101
Every 12th month (Annually).....	102
Every 24th month (Every other year) .....	102

---

Service - Checklist .....	103
Maintenance, 10h .....	105
Check - Coolant system .....	105
Diesel engine Check oil level .....	106
Hydraulic reservoir, Level check - Filling.....	107
Air circulation - Check .....	107
Fuel tank - Filling.....	108
Water tank - Filling .....	108
Sprinkler system/Drum	
Checking - Cleaning.....	109
Sprinkler - Drain / Anti-freeze.....	109
Sprinkler system/Drum	
Cleaning of sprinkler nozzle .....	110
Scrapers, fixed	
Checking - Setting.....	111
Scrapers, spring-action (Optional)	
Checking - Adjustment .....	111
Brakes - Check.....	112
Maintenance, first 50h.....	113
Engine oil and oil filter - Change .....	113
Replacing the hydraulic oil filter .....	115
Bolted joints	
Check .....	116
Maintenance - 50h .....	117
Air cleaner	
Check main filter .....	117
Steering cylinder and steering joint - Lubrication .....	118
Checking the fuel hoses and hose clamps.....	119
Water separator - Draining	
(on machines equipped with this).....	120
Maintenance measures - 250 h .....	121
Battery	
- Check condition .....	121

---

Engine oil and oil filter - Change .....	122
Air cleaner	
- Cleaning.....	123
Replacing belts/Checking the belt tension .....	124
Check - Coolant system .....	125
Check - Air intake hoses .....	126
Maintenance - 500h .....	127
Battery	
- Check condition .....	127
Engine oil and oil filter - Change .....	128
Drum - oil level	
Inspection - filling .....	129
Rubber elements and bolted joints	
Check .....	130
Hydraulic reservoir cap - Check .....	130
Steering cylinder and steering joint - Lubrication .....	131
Check - Coolant system .....	131
Air cleaner	
Check - Replacement of main filter .....	132
Air filter indicator - Resetting .....	132
Replacing the fuel filter.....	133
Replacing the pre-filter .....	133
D1703 .....	134
D1803 .....	134
Check - Air intake hoses .....	135
Fuel tank - Cleaning .....	136
Fuel filter's water separator - Draining	
(on machines equipped with this).....	136
Coolers	
Checking - Cleaning.....	137
Replacing belts/Checking the belt tension .....	138
Maintenance - 1000h .....	139

Battery	
- Check condition .....	139
Engine oil and oil filter - Change .....	140
Drum - oil level	
Inspection - filling .....	141
Rubber elements and bolted joints	
Check .....	142
Hydraulic reservoir cap - Check .....	142
Steering cylinder and steering joint - Lubrication .....	143
Check - Coolant system .....	143
Air cleaner	
Check - Replacement of main filter .....	144
Air filter indicator - Resetting .....	144
Backup filter - Change.....	145
Replacing the fuel filter.....	145
Replacing the pre-filter .....	146
D1703 .....	146
D1803 .....	146
Fuel tank - Cleaning .....	147
Coolers	
Checking - Cleaning .....	147
Checking of EGR cooler.....	147
Check - Air intake hoses .....	148
Replacing the hydraulic oil filter .....	149
Replacing belts/Checking the belt tension .....	150
Maintenance measures - 1500 h (only T4f, T5 (28 kW)) .....	151
Check - Spreader .....	151
Check - EGR cooler .....	151
Replacing the oil separator .....	151
Checking of injector tip .....	152
Maintenance - 2000h .....	153



Battery	
- Check condition .....	153
Engine oil and oil filter - Change .....	154
Rubber elements and bolted joints	
Check .....	155
Hydraulic reservoir cap - Check .....	155
Steering cylinder and steering joint - Lubrication .....	156
Check - Coolant system .....	156
Air cleaner	
Check - Replacement of main filter .....	157
Air filter indicator - Resetting .....	157
Backup filter - Change.....	158
Replacing the hydraulic oil filter .....	159
Replacing the fuel filter.....	160
Replacing the pre-filter .....	160
D1703 .....	161
D1803 .....	161
Fuel tank - Cleaning .....	161
Coolers	
Checking - Cleaning.....	162
Water tank - Draining .....	162
Water tank - Cleaning .....	163
Checking of EGR cooler.....	163
Hydraulic reservoir - fluid change.....	164
Drum - Oil change .....	165
Steering joint - Check.....	166
Edge cutter (Optional)	
- Lubrication .....	166
Replacing belts/Checking the belt tension .....	167
Maintenance, 3000h .....	169
Battery	
- Check condition .....	169

Engine oil and oil filter - Change .....	170
Drum - oil level	
Inspection - filling .....	171
Rubber elements and bolted joints	
Check .....	172
Hydraulic reservoir cap - Check .....	172
Steering cylinder and steering joint - Lubrication .....	173
Check - Coolant system .....	173
Air cleaner	
Check - Replacement of main filter .....	174
Air filter indicator - Resetting .....	174
Backup filter - Change.....	175
Water tank - Cleaning .....	175
Replacing the hydraulic oil filter .....	176
Water tank - Draining .....	177
Replacing the pre-filter .....	177
D1703 .....	178
D1803 .....	178
Fuel tank - Cleaning .....	178
Coolers	
Checking - Cleaning.....	179
Checking of EGR cooler.....	179
Replacing the fuel filter.....	180
Hydraulic reservoir - fluid change.....	181
Draining of water separator.....	182
Check - Air intake hoses .....	183
Cleaning of DPF (D1803 only) .....	184
Checking the EGR system (only D1803) .....	184
Checking the injection pump (only D1703) .....	184
Steering joint - Check.....	184
Replacing belts/Checking the belt tension .....	185

Maintenance, every 12th month (Annually) .....	187
Air cleaner	
Check - Replacement of main filter .....	187
Air filter indicator - Resetting .....	187
Backup filter - Change.....	187
Checking the DPF pipes and connections (only D1803).....	187
Checking the EGR pipes and connections (only D1803) .....	188
Check the Manifold (only D1803).....	188
Maintenance, every 24th month (Every other year).....	189
Check - Coolant system .....	189
Check - Air intake hoses .....	190



## Introduction

### The machine

Dynapac CC1100 VI / 1200 VI are two self-propelled vibratory tandem rollers in the 2 metric tonnes class featuring 1100/1200 mm wide drums. The machines are equipped with drive, brakes, and vibration on both drums.

### Intended use

The rollers are mainly intended for compaction of thin layers and soft asphalt masses for minor construction work, such as small streets, pavements, cycle paths and garage drives. It has sufficient capacity to follow a small asphalt paver.

### Warning symbols



**WARNING !** Marks a danger or a hazardous procedure that can result in life threatening or serious injury if the warning is ignored.



**CAUTION !** Marks a danger or hazardous procedure that can result in damage to the machine or property if the warning is ignored.

### Safety information




**It is recommended to at least train operators in handling and daily maintenance of the machine in accordance with the instruction manual. Passengers are not allowed on the machine, and you must sit in the seat when operating the machine.**





**The safety manual supplied with the machine must be read by all roller operators. Always follow the safety instructions. Do not remove the manual from the machine.**



**We recommend that the operator reads the safety instructions in this manual carefully. Always follow the safety instructions. Ensure that this manual is always easily accessible.**


 **Read the entire manual before starting the machine and before carrying out any maintenance.**

 **Replace immediately the instruction manuals if lost, damaged or unreadable.**

 **Ensure good ventilation (extraction of air by fan) where the engine is run indoors.**

CALIFORNIA  
**Proposition 65**

Decal and location of decal shown in section  
Machine description.

 **WARNING:** Breathing diesel engine exhaust exposes you to chemicals known to the State of California to cause cancer and birth defects or other reproductive harm.

- Always start and operate the engine in a well-ventilated area.
- If in an enclosed area, vent the exhaust to the outside.
- Do not modify or tamper with the exhaust system.
- Do not idle the engine except as necessary.

For more information go to [www.P65warnings.ca.gov/diesel](http://www.P65warnings.ca.gov/diesel).

### General

This manual contains instructions for machine operation and maintenance.

The machine must be correctly maintained for maximal performance.

The machine should be kept clean so that any leakages, loose bolts and loose connections are discovered at as early a point in time as possible.

Do not spray with high-pressure cleaner directly onto gaskets and bearing spacings in steering hitch and drum, and electronics.

Inspect the machine every day, before starting.  
Inspect the entire machine so that any leakages or other faults are detected.

Check the ground under the machine. Leakages are more easily detected on the ground than on the machine itself.



**THINK ENVIRONMENT !** Do not release oil, fuel and other environmentally hazardous substances into the environment. Always send used filters, drain oil and fuel remnants to environmentally correct disposal.

This manual contains instructions for periodic maintenance, where maintenance after every 10 and 50 hours of operation can be performed by the machine operator. Other maintenance intervals must be carried out by accredited (Dynapac) service personnel.



Additional instructions for the engine can be found in the manufacturer's engine manual.

Specific maintenance and checks on diesel engines must be carried out by the engine supplier's certified personnel.

### **CE marking and Declaration of conformity**

(Applies to machines marketed in EU/EEC)

This machine is CE marked. This shows that on delivery it complies with the basic health and safety directives applicable for the machine in accordance with machinery directive 2006/42/EC and that it also complies with other regulations and directives applicable for this machine.

A "Declaration of conformity" is supplied with this machine, which specifies the applicable regulations and directives with supplements, as well as the harmonized standards and other regulations that are applied and according to the regulations must be declared in writing.





**Safety - General instructions**

(Also read the safety manual)



- The operator must be familiar with the contents of the **OPERATION** section before starting the roller.
- Ensure that all instructions in the **MAINTENANCE** section are followed.
- Only the operator is allowed to be on the roller. Remain seated at all times when operating the roller.
- Never use the roller if it is in need of adjustment or repair.
- Only ascend and descend the roller when it is stationary. Use the intended footsteps, grips and rails. Always use the three-point grip (both feet and one hand, or one foot and both hands) when ascending or descending the machine. Never jump down from the machine.
- Dynapac always recommends mounted ROPS (Roll Over Protective Structure), or a ROPS-approved cab and seat belt usage.
- Drive slowly in sharp bends.
- Avoid driving across slopes. Drive straight up or straight down the slope.
- Never operate with roller outside the edge, if the substrate does not have full bearing strength or is close to a slope. Avoid operating close to edges and ditches and the like as well as on poor ground conditions that jeopardizes the bearing strength and capacity to support the roller.
- Make sure that there are no obstacles in the direction of travel, on the ground, in front of or behind the roller, or overhead.
- Drive particularly carefully on uneven ground.
- Keep the roller clean. Clean any dirt or grease that accumulates on the operator platform immediately. Keep all signs and decals clean and legible.
- Safety measures before refueling:
  - Stop the engine
  - Do not smoke.
  - No naked flames in the vicinity of the roller.
  - Earth the filling equipment nozzle to the tank opening to avoid sparks.
- Before repairs or service:
  - Chock the drums/wheels.
  - Lock the articulation if necessary.
  - Place blocks under overhanging equipment, such as strike-off blade and chip spreader.
- Hearing protection is recommended if the noise level exceeds 80 dB(A). The noise level can vary depending on the equipment on the machine and the surface the machine is being used on.

- **Do not make any changes or modifications to the roller that could affect safety. Changes are only to be made after written approval has been given by Dynapac.**
- **Avoid using the roller before the hydraulic fluid has reached its normal working temperature. Braking distances can be longer than normal when the fluid is cold. See instructions in the STOP section.**
- **For your own protection always wear:**
  - **helmet**
  - **working boots with steel toecaps**
  - **ear protectors**
  - **reflecting clothing/high visibility jacket**
  - **working gloves**
- **If the machine seems to be responding abnormally during travel, stop and check it.**

### Safety - when operating



**Prevent persons from entering or remaining in the danger area, i.e. a distance of at least 7 m (23 ft) in all directions from operating machines. The operator may allow a person to remain in the risk zone, however he/she must be attentive and operate the machine only when the person is fully visible or has given a clear indication of where he or she is.**



**Avoid driving across a slope. Drive straight up and down sloping ground.**

### Work driving

Avoid operating close to edges and ditches and the like as well as on poor ground conditions that jeopardizes the bearing strength and capacity to support the roller. Pay attention to potential obstacles above the machine, such as overhead cables and the branches of trees etc.

Pay particular attention to the stability of the substrate when compacting close to edges and holes. Do not compact with a large overlap from the previous track in order to maintain roller stability. Consider other compaction methods such as remote-control or a walk-behind roller close to steep slopes or where the bearing strength of the substrate is unknown.



**Dynapac always recommends mounted ROPS (Roll Over Protective Structure) and seat belt usage.**

**On machines with foldable ROPS, make sure that the ROPS is correctly mounted in the upright position during all operation.**

**Driving near edges**



*Never operate with roller outside the edge, if the substrate does not have full bearing strength or is close to a slope.*



*Keep in mind that the machine's center of gravity moves outwards when steering. For example, the center of gravity moves to the right when you steer to the left.*

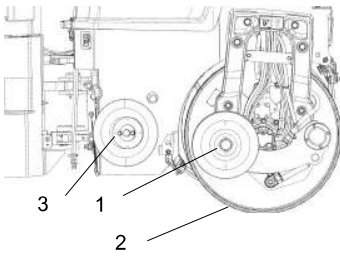






Fig. Edge cutter/compactor  
1. Transport position  
2. Operating position  
3. Holder for cutter/compactor wheel.

### Safety (Optional)

#### Edge cutter/compactor

-  **The operator must make sure that nobody is in the area of operation while the machine is in use.**
-  **The edge cutter consists of rotating components and there is a risk of being crushed.**
-  The tool must be returned to the transport position (raised position) (1) every time it has been used.
-  **If the edge cutter and its parts are dismantled, make sure that it is set in a relieved position and resting on the ground.**

#### Chip spreader

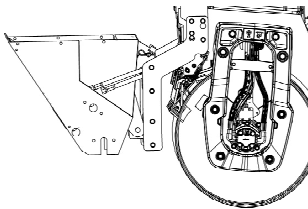







Fig. Chip spreader

-  **The machine must not be lifted or transported on another vehicle with chips in the chip spreader. The weight for the chip spreader is specified on the unit rating plate. This weight is not included in the machine weight specified on the lifting plate.**
-  **The operator must make sure that nobody is in the area of operation while the machine is in use.**
-  **The machine must NOT be lifted from a single-point lift if the chip spreader is fitted.**
-  **Risk of crushing and pinch injuries. The chip spreader has rotating parts.**
-  The chip spreader must be reset in transport mode after it has been used.



Fitting the chip spreader changes the total length of the machine.

### Special instructions

#### Standard lubricants and other recommended oils and fluids

Before leaving the factory, the systems and components are filled with the oils and fluids specified in the lubricant specification. These are suitable for ambient temperatures in the range -15°C to +40°C (5°F - 105°F).



The maximum ambient temperature for biological hydraulic fluid is +35°C (95°F).

#### Higher ambient temperatures, above +40°C (104°F)

For operation of the machine at higher ambient temperatures, however maximum +50°C (122°F), the following recommendations apply:

The diesel engine can be run at this temperature using normal oil. However, the following fluids must be used for other components:

Hydraulic system - mineral oil Shell Tellus S2V100 or similar.

#### Lower ambient temperature - Freeze risk

Make sure that the watering system is empty/drained of water (sprinkler, hoses, tank/s) or that anti-freeze has been added, to prevent the system freezing.

Close the ball valve and draw up the anti-freeze liquid through the filter. See the chapter dealing with Sprinkler system.

#### Temperatures

The temperature limits apply to standard versions of rollers.


Rollers equipped with additional equipment, such as noise suppression, may need to be more carefully monitored in the higher temperature ranges.

#### High pressure cleaning

Do not spray water directly onto electrical components or the instrument panels.

Place a plastic bag over the fuel filler cap and secure with a rubber band. This is to avoid high pressure water entering the vent hole in the filler cap. This could cause malfunctions, such as the blocking of filters.

Do not spray with high-pressure cleaner directly onto gaskets and bearing spacings in steering hitch and drum, and electronics.


 Never aim the water jet directly at the fuel tank cap, or into exhaust pipe. This is particularly important when using a high-pressure cleaner.

### Fire fighting

If the machine catches fire, use an ABC-class powder fire extinguisher.

A BE-class carbon dioxide fire extinguisher can also be used.

### Roll Over Protective Structure (ROPS)

 **Never carry out any welding or drilling in the Roll Over Protective Structure (ROPS).**


 **Never repair a damaged ROPS structure, it must be replaced with a new one.**

### Battery handling

 **When removing batteries, always disconnect the negative cable first.**

 **When fitting batteries, always connect the positive cable first.**

 Dispose of old batteries in an environmentally friendly way. Batteries contain toxic lead.

 Do not use a quick-charger for charging the battery. This may shorten battery life.



**Jump starting**



**Do not connect the negative cable to the negative terminal on the dead battery. A spark can ignite the oxy-hydrogen gas formed around the battery.**



**Check that the battery used for jump starting has the same voltage as the dead battery.**

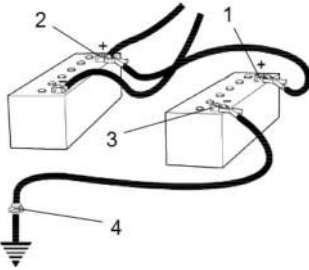


Fig. Jump starting

Turn the ignition and all power consuming equipment off. Switch off the engine on the machine which is providing jump start power.

First connect the jump start battery's positive terminal (1) to the flat battery's positive terminal (2). Then connect the jump start battery's negative terminal (3) to, for example, a bolt (4) or the lifting eye on the machine with the flat battery.

Start the engine on the power providing machine. Let it run for a while. Now try to start the other machine. Disconnect the cables in the reverse order.



**Technical specifications****Vibrations - Operator station  
(ISO 2631)**

**The vibration levels are measured in accordance with the operational cycle described in EU directive 2000/14/EC on machines equipped for the EU market, with vibration switched on, on soft polymer material and with the operator's seat in the transport position.**

Measured whole-body vibrations are below the action value of 0.5 m/s<sup>2</sup> as specified in Directive 2002/44/EC. (Limit is 1.15 m/s<sup>2</sup>)

Measured hand/arm vibrations also were below the action level of 2.5 m/s<sup>2</sup> specified in the same directive. (Limit is 5 m/s<sup>2</sup>)

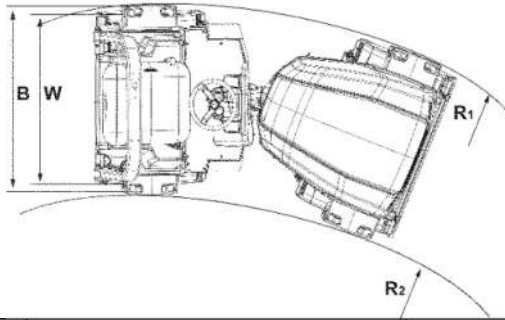
**Noise level**

**The noise level is measured in accordance with the operational cycle described in EU directive 2000/14/EC on machines equipped for the EU market, with the vibration switched on, on soft polymer material and with the operator's seat in the transport position.**

Guaranteed sound power level, $L_{wA}$	106	dB (A)
Sound pressure level at the operator's ear (platform), $L_{pA}$	80 ±3	dB (A)

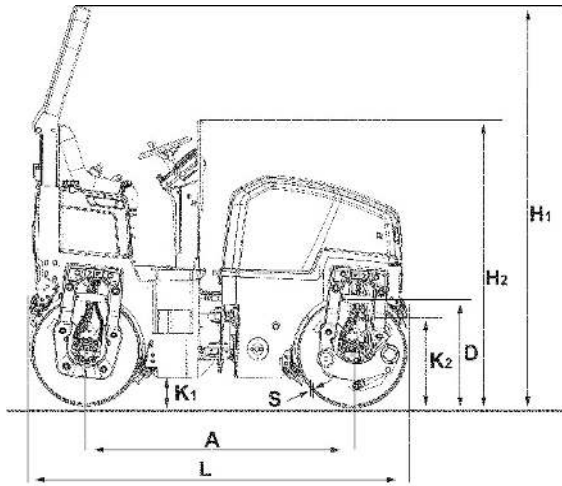
---

**During operation the above values may differ because of the actual operational conditions.**

**Dimensions, top view**


	Dimensions	mm	in
B	Machine width		
	CC1100 VI	1210	48
	CC1200 VI	1340	53
B (without ROPS)	Machine width		
	CC1100 VI	1210	48
	CC1200 VI	1340	53
R <sub>1</sub>	Turning radius, outer		
	CC1100 VI	3710	146
	CC1200 VI	3770	148
R <sub>2</sub>	Turning radius, inner		
	CC1100 VI	2640	104
	CC1200 VI	2570	101
W	Drum width		
	CC1100 VI	1070	42
	CC1200 VI	1200	47

Dimensions, side view



	Dimensions	mm	in
A	Wheel base	1700	67
D	Diameter, drum	700	27
H <sub>1</sub>	Height, with ROPS	2542	100
H <sub>2</sub>	Height, without ROPS	1744	68.5
K <sub>1</sub>		180	7
K <sub>2</sub>		550	22
L	Length	2400	94
	Length, with chip spreader	3220	127
S	Thickness, drum amplitude, Nominal		
	CC1100 VI	12	0.47
	CC1200 VI	13	0.51

**Weights and volumes**
**Fluid volumes**

Fuel tank	46 liters	48.6 qts
Water tank	205 liters	216.6 qts

**Weights**

Weight CECE, Standard equipped roller (including ROPS)

CC1100 VI	2402 kg	5.295 lbs
CC1200 VI	2600 kg	5.735 lbs

**Working capacity**
**Compaction data**

Static linear load (front/rear)		
CC1100 VI	10.7/11.8 kg/cm	59.9/66.1 pli
CC1200 VI	10.3/11.4 kg/cm	57.7/63.8 pli
Amplitude	0.5 mm	0.02 in
Vibration frequency		
D1703	66/61 Hz	3960/3660 vpm
D1803	65/61 Hz	3900/3660 vpm
Centrifugal force		
CC1100 VI		
- D1703	29/25 kN	6519/5620 lb
- D1803	28/25 kN	6295/5620 lb
CC1200 VI		
- D1703	34/29 kN	7644/6520 lb
- D1803	33/29 kN	7419/6520 lb

**Propulsion**

Speed range	0-10	km/h	0-6.2	mph
Climbing capacity (theoretical)				
CC1100 VI	up to 46*	%		
CC1200 VI	up to 42*	%		

\*) depending on model, diesel engine, other equipment and operating conditions.

### General

#### Engine

Manufacturer/Model	Kubota D1703-M-IDI E3B	(IIIA/T3)
	Kubota D1703-M-DI-E4B	(T4f, T5)
	Kubota D1803-CR	(T4f, T5)
Power (SAE J1995)	26.1 kW (IIIA/T3)	35 hp
	18,5 kW (T4f, T5)	25 hp
	28.0 kW (T4f, T5)	38 hp
Engine speed	2800 rpm (IIIA/T3)	
	2200 rpm (T4f, T5)	
	2700 rpm (T4f, T5)	

#### CO<sub>2</sub>-emission

CO<sub>2</sub>-emissions measured according to applicable test cycle in Regulation (EU) 2016/1628.

Manufacturer/Model		Test-cycle	CO <sub>2</sub> -emission (g/kWh)
Kubota D1703-M-DI-E4B (18.5 kW) (T5)	Stage V	NRSC	938.3
Kubota D1803-CR-E5B (28 kW) (T5)	Stage V	NRTC	858.7
Kubota D1803-CR-E5B (28 kW) (T5)	Stage V	NRSC	802.7

NRTC: Non-road transient test cycles

NRSC: Non-road steady-state test cycles

#### Electrical system

Battery	12V 74Ah
Alternator	12V 60A
Fuses	See the Electrical system section - fuses

### Tightening torque

Tightening torque in Nm for oiled or dry bolts tightened with a torque wrench.

Metric coarse screw thread, bright galvanized (fzb):

#### STRENGTH CLASS:

M - thread	8.8, Oiled	8.8, Dry	10.9, Oiled	10.9, Dry	12.9, Oiled	12.9, Dry
<b>M6</b>	8,4	9,4	12	13,4	14,6	16,3
<b>M8</b>	21	23	28	32	34	38
<b>M10</b>	40	45	56	62	68	76
<b>M12</b>	70	78	98	110	117	131
<b>M14</b>	110	123	156	174	187	208
<b>M16</b>	169	190	240	270	290	320
<b>M20</b>	330	370	470	520	560	620
<b>M22</b>	446	497	626	699	752	839
<b>M24</b>	570	640	800	900	960	1080
<b>M30</b>	1130	1260	1580	1770	1900	2100

Metric coarse thread, zinc-treated (Dacromet/GEOMET):

#### STRENGTH CLASS:

M - thread	10.9, Oiled	10.9, Dry	12.9, Oiled	12.9, Dry
<b>M6</b>	12,0	15,0	14,6	18,3
<b>M8</b>	28	36	34	43
<b>M10</b>	56	70	68	86
<b>M12</b>	98	124	117	147
<b>M14</b>	156	196	187	234
<b>M16</b>	240	304	290	360
<b>M20</b>	470	585	560	698
<b>M22</b>	626	786	752	944
<b>M24</b>	800	1010	960	1215
<b>M30</b>	1580	1990	1900	2360



**!** ROPS-bolts which are to be torque tightened must be dry.

### ROPS - bolts

Bolt dimensions :	M16 (PN 4700902889)
Strength class :	8.8
Tightening torque :	190 Nm (Dacromet treated)

### Hydraulic system

Opening pressure (Absolute pressure)	MPa
Drive system	35,0
Supply system	2,0
Vibration system	21,0
Control systems	18,0
Brake release	1,2 - 3,0



Max 20° or 36%

### Slopes

This angle has been measured on a hard, flat surface with the machine stationary.

The steering angle was zero, the vibration was switched OFF and all tanks were full.

Always take into consideration that loose ground, steering the machine, vibration on, machine speed across the ground and raising the center of gravity can all cause the machine to topple at smaller slope angles than those specified here.



## Machine description

### Diesel engine

The machine is equipped with a water-cooled, straight three cylinder, four-stroke, diesel engine.

### Electrical system

The machine has the following control units (ECU, Electronic Control Unit) and electronic units.

- Main ECU (for the machine)
- Engine ECU (for D1803-CR (T4f, T5 (28 kW)))

### Propulsion system/Transmission

The propulsion system is a hydrostatic system with a hydraulic pump supplying two motors connected in parallel.

The motors drive the front and rear drums.

The speed of the machine is proportional to the deflection/angle of the control lever from neutral.

### Brake system

The brake system consists of a service brake, secondary brake and parking brake.

The service brake is hydrostatic and is activated by moving the control lever to neutral.

### Secondary/Parking brake

The secondary and parking brake system consists of sprung multiple disc brakes in the motors. The brakes are released with hydraulic pressure and are operated with a switch on the instrument panel.

### Steering system

The steering system is a hydrostatic system.

The control valve on the steering column distributes the flow to the control cylinder, which actuates the articulation.

The steering angle is proportional to the deflection of the steering wheel.

### ROPS

ROPS is the abbreviation for "Roll Over Protective Structure".

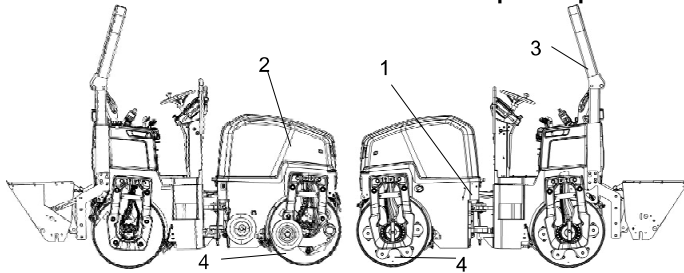
If any part of the ROPS structure's protective construction displays plastic deformation or cracks, the ROPS structure must be replaced immediately.

Never perform any modifications on the ROPS structure without first having discussed the

modification with Dynapac's production unit. Dynapac determines whether the modification could result in the approval according to the ROPS standards becoming invalid.

### Identification

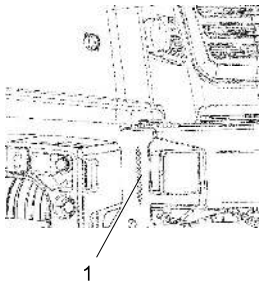
#### Product and component plates



1. Product plate - Product Identification Number (PIN), model/type designation
2. Engine plate - Type description, product and serial numbers
3. ROPS plate - Certification, product and serial numbers
4. Component plate, drum - Product and serial numbers

#### Product identification number on the frame

The machine PIN (product identification number) (1) is punched on the right side of the front frame.



**Fig. PIN Front frame**  
1. Serial number

100	00123	V	x	A	123456
A	B	C	F		

### Explanation of 17PIN serial number

- A= Manufacturer
- B= Family/Model
- C= Check letter
- F= Serial number

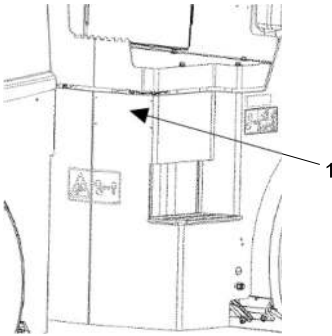


Fig. Operator platform  
1. Machine plate

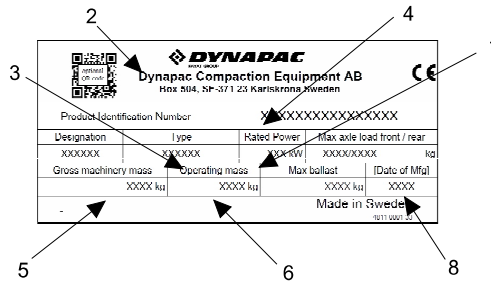
### Machine plate

The machine type plate (1) is affixed on the rear left edge of the frame.

The plate includes:

- name and address of the manufacturer (2)
- type of machine (3)
- PIN-product identification number (serial number) (4)
- maximum weight (5)
- service weight (6)
- engine power (7)
- year of manufacture (8)

If the machine is delivered outside of the EU, the plate may not have a CE marking and the year of manufacture.



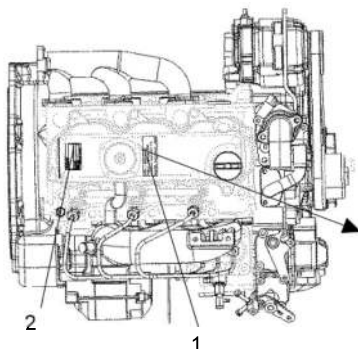
Please state the machine's PIN (serial number) when ordering parts.

**Engine plates**

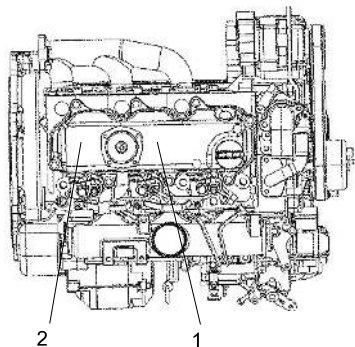
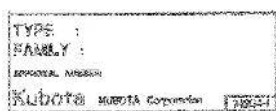
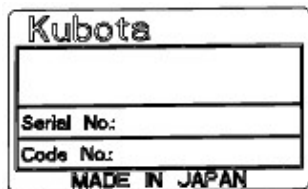
The engine's type plate (1) is located on top of the cylinder head cover.

The plate specifies the type of engine, its serial number and the engine specification.

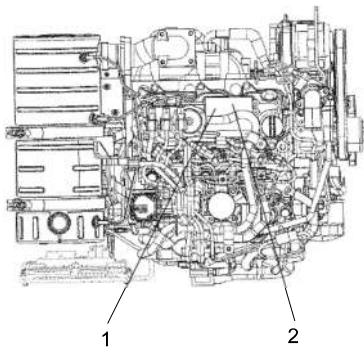
**Please specify the engine serial number when ordering spares. Refer also to the engine manual.**



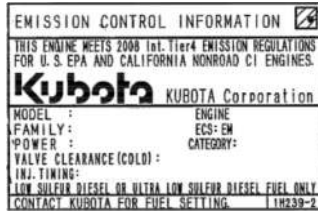
**Fig. Engine - D1703-M-IDI-E3 (T3)**  
 1. Type plate  
 2. Engine series plate

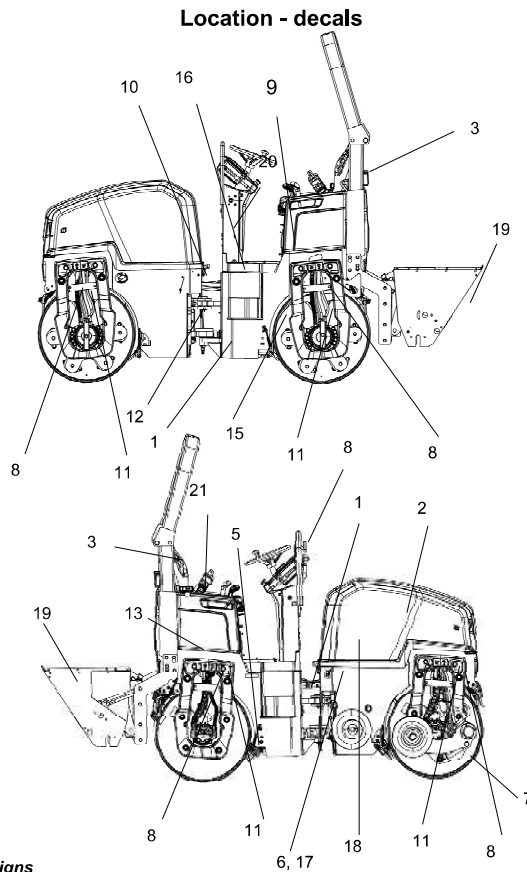


**Fig. Engine - D1703-M-DI-E4B (T4f, T5)**  
 1. Type plate  
 2. Engine series plate



**Fig. Engine - D1803 CR (T4f, T5)**  
 1. Type plate  
 2. Engine series plate





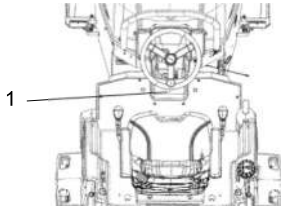
**Fig. Location, decals and signs**

1.	Warning, Crush zone	4700903422	12.	Sound power level	4700791292
2.	Warning, Rotating engine components	4700903423	13.	Hydraulic fluid level	4700272373
3.	Warning, Crushing risk	4700908229	14.	Warning, Starting gas	4700791642
4.	Warning, Instruction manual	4700903459	15.	Warning, Locking during transport	4812125363
5.	Warning, Hot surfaces	4700903424	16.	Flow divider (optional)	4700355981
6.	Diesel fuel	4700991658	17.	Diesel fuel (T4f, T5)	4811000345
7.	Warning, edge cutter	4700904083	18.	Fuel with ultra low sulphur content (T4f, T5)	4811000344
8.	Lifting point	4700357587	19.	Warning - Chip spreader, rotating components	4811000080
9.	Manual compartment	4700903425	20.	Location - decals, CALIFORNIA Proposition 65	4812129673
10.	Battery disconnecter	4700904835	21.	Forward / Reverse lever	4812130376
11.	Fixing point	4700382751			



**Location - decals, CALIFORNIA**

Proposition 65



- 1. Warning, CALIFORNIA Proposition 65 4812129673

Fig. Location

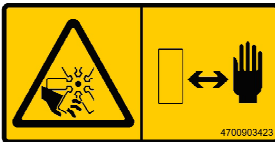
**Safety decals**

Always make sure that all safety decals are completely legible, and remove dirt or order new decals if they have become illegible. Use the part number specified on each decal.



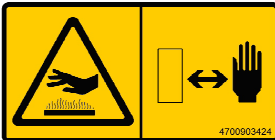
**4700903422**  
**Warning - Crush zone, articulation/drum.**

**Maintain a safe distance from the crush zone.**  
*(Two crush zones on machines fitted with pivotal steering)*



**4700903423**  
**Warning - Rotating engine components.**

**Keep your hands at a safe distance.**



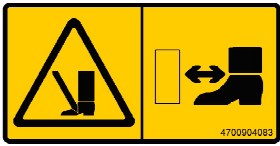
**4700903424**  
**Warning - Hot surfaces in the engine compartment.**

**Keep your hands at a safe distance.**



**4700903459**  
**Warning - Instruction manual**

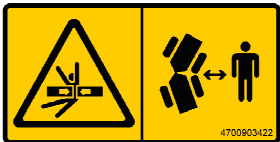
The operator must read the safety, operation and maintenance instructions before operating the machine.



**4700904083**  
**Warning - Edge cutter (option)**

Warning of rotating parts.

Maintain a safe distance from the crush zone.



**4700903422**  
**Warning - Crush zone, chip spreader (optional)**

Risk of personal injury or being crushed.

Keep well clear of the spreader's working area



**4700908229**  
**Warning - Risk of crushing**

The articulation must be locked when lifting.

Read the instruction manual.



**4812125363**  
**Warning - Locking**

The articulation must be locked during transport and lifting,

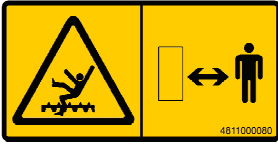
but be open during operation.

Read the instruction manual.



**4700791642**  
**Warning - Starting gas**

Starting gas is not to be used.



**4811000080**  
**Warning - Chip spreader (optional)**

**The spreader has rotating components.**

Never insert your hands or any objects when the spreader is in operation.

Always stop the roller motor before carrying out adjustments or maintenance on the spreader.

4812129673  
Warning

CALIFORNIA - Proposition 65



# WARNING

Breathing diesel engine exhaust exposes you to chemicals known to the State of California to cause cancer and birth defects or other reproductive harm.

- Always start and operate the engine in a well-ventilated area.
- If in an enclosed area, vent the exhaust to the outside.
- Do not modify or tamper with the exhaust system.
- Do not idle the engine except as necessary.

For more information go to  
[www.P65warnings.ca.gov/diesel](http://www.P65warnings.ca.gov/diesel)

4812129673

Info decals

Noise power level



Diesel fuel



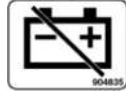
Lifting point



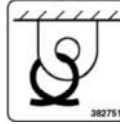
Manual compartment



Battery disconnecter



Fixing point



Bio hydraulic fluid, PANOLIN



Hydraulic fluid level



Water



Flow divider (optional)



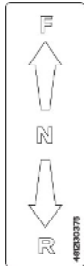
Fuel with ultra low sulphur content (T4f, T5)



(T4f, T5)



Forward- / Reverse lever



**Instruments/Controls**

**Locations - Control panel and controls**

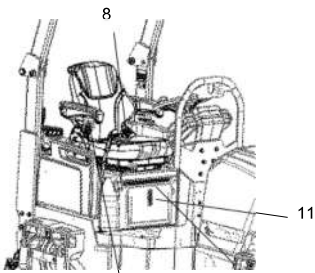


Fig. Operator position

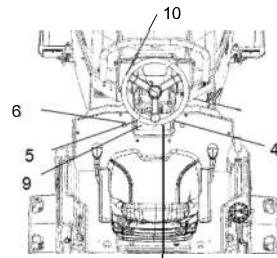
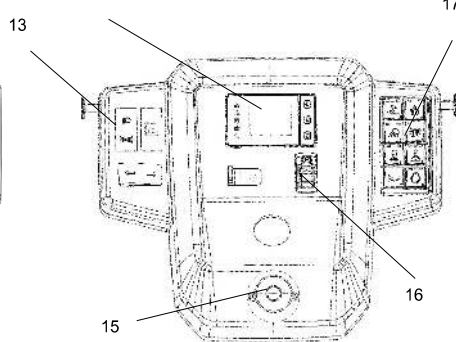
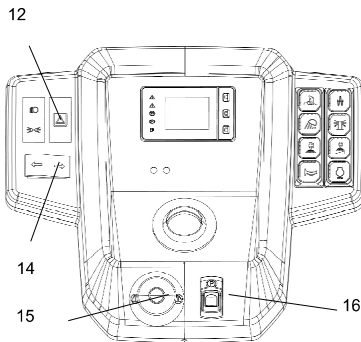
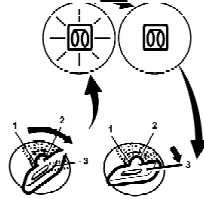
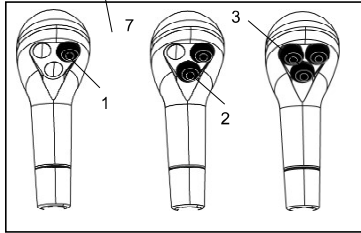
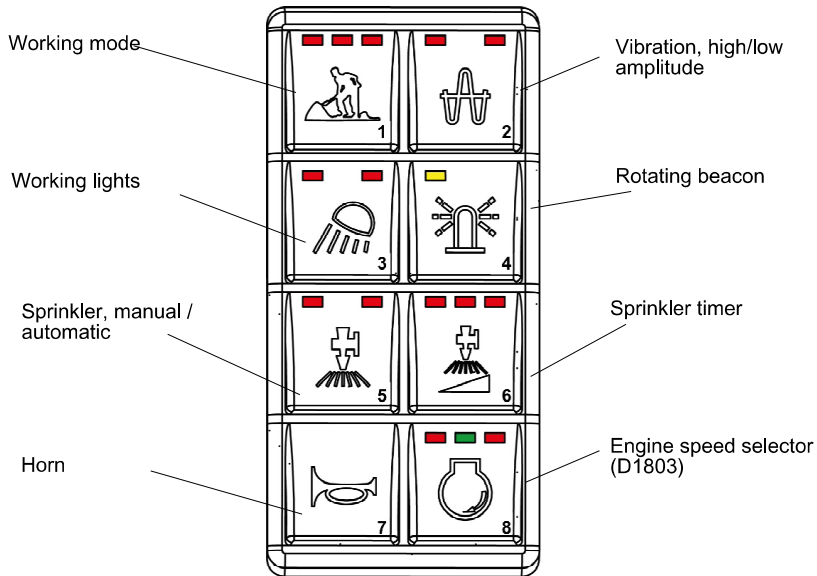


Fig. Operator's station



- |                                 |                         |                                      |
|---------------------------------|-------------------------|--------------------------------------|
| 4. Ignition key                 | 9. Fuse holder          | 14. * Direction selector / indicator |
| 5. Engine speed control (D1703) | 10. Instrument cover    | 15. Emergency stop                   |
| 6. * Flow divider               | 11. Storage compartment | 16. Parking brake                    |
| 7. Forward/Reverse lever        | 12. * Hazard indicators | 17. Membrane panel / Function keys   |
| 8. Seat switch                  | 13. * Driving lights    | 18. Control panel/Display            |
- \* = Optional










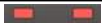
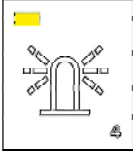

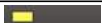
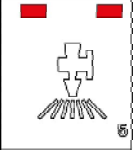



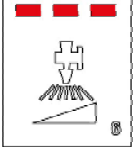




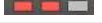
### Functional description - Membrane panel








### Function description - Display

Designation	Function
Vibration ON/OFF	When button 1 and/or button 2 are pressed in and <b>Working mode/Vibration</b> is activated, vibrations are enabled. Press again and the vibrations are disconnected. (See figure at the top)
Selection of drum	In <b>Working mode/Vibration</b> with the help of button 1 or button 2 you can select on which of the drums that the vibration should start, or vibration on both drums. (See figure at the top)
Edge cutter, down/up	In <b>Working mode/Edge cutter</b> Using button 2 the edge cutter is lowered. With button 3 the edge cutter is raised. Using button 1 you select vibration of front drum.
Chip spreader, on/off	In <b>Working mode/Chip spreader</b> activates the chip spreader with button 2. (See figure at the top)

## Machine description

LED	Designation	Function	LED	LED color
	Working mode (vibration and edge cutter (optional) permitted)	Activates working mode, which makes it possible to use vibration and edge cutter (optional).		
		LED OFF = Transport mode		-
		LED LEFT = Working mode, vibration		Red
		LED CENTER = Working mode, edge cutter (Optional)		
		LED RIGHT = Working mode, chip spreader (Optional)		
	Vibration, High/Low amplitude ( <b>Not</b> on these models)			
	Working lights, switch	Enables working lights for ROPS and / or Frame		
		LED OFF = OFF		
		LED LEFT = Working lights, Frame		Red
		LED RIGHT = Working lights, Frame and ROPS (Optional)		
	Rotating beacon, switch (Optional)	Enables the rotating beacon		
		LED Off = OFF		-
		LED LEFT = ON		Yellow
	Sprinkler, manual / automatic	Enables the sprinkler system		
		LED OFF = No function		-
		LED LEFT = Manual sprinkler		Red
		LED RIGHT = Automatic sprinkler		
	Sprinkler timer			
		LED OFF = No timer function Continuously on when the lever is not in the neutral position.		-
		LED LEFT = Minimal amount of water		Red
		LED CENTER = Increased amount of water		
		LED RIGHT = Maximal amount of water		



LED	Designation	Function	LED	LED color
	Horn, switch	Press to sound the horn.		
	Engine speed selector (D1803)	Only activated for electronic controlled engine speed (D1803)		
		LED LEFT = Low speed		Red
		LED CENTER = ECO low working revs		Green
		LED RIGHT = High working revs		Red

### Function description - Display

#### Display explanations



Fig. Start image

When the ignition lock is activated to position I a start image is shown on the display. This image is visible for three seconds and then changes to Transport/Working mode.

The transport mode menu is shown when one of the three function keys to the right on the display is activated.



Fig. Transport mode

### Transport mode

The transport mode screen provides information about travel direction (2), machine hours (3) and fuel level (4).

#### 2. Direction of travel

- The icon has three options (F, N, R) and is shown in the top left of the display. Only current status is displayed.

- **N** (Neutral) shows that the control lever is in the neutral position and no travel direction arrow is shown on the display.

- **F** (Forwards) an arrow directed left is shown in front of "F" on the display.

- **R** (Backwards) an arrow directed right is shown after "R" on the display.

#### 3. Machine hours:

- An icon (hour glass) is shown on the left-hand side of the display for machine hours. The number of hours is shown to the right of the icon in digits.

#### 4. Fuel level:

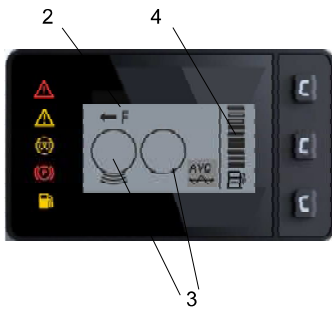
- The fuel level is indicated as a percentage (%) on the bar to the right of the display.

When only the lowest step on the bar is filled, there is 10% of the fuel remaining in the tank and the warning lamp for the fuel level (6) lights.



**Working mode, Vibration**

The different working modes are selected with the help of the working mode button on the panel.



**Fig. Working mode, Vibration both drums**

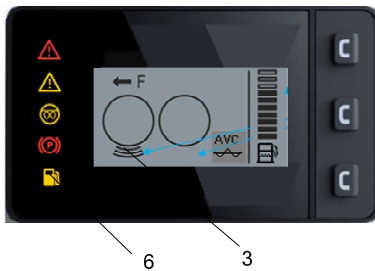
**2. Direction of travel**

- The icon has three options (F, N, R) and is clearly visible in the top left of the display. Only one can be selected.

- **N** (Neutral) shows that the control lever is in the neutral position and no arrow is shown on the display.

- **F** (Forwards) an arrow directed left is shown in front of "F" on the display.

- **R** (Backwards) an arrow directed right is shown after "R" on the display.



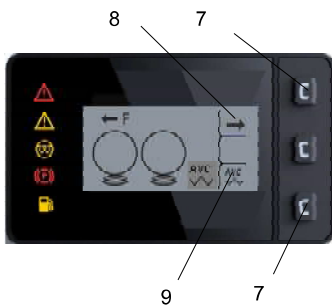
**Fig. Working mode, Vibration front drum**

**3. Compaction status (off/on) on front/rear drum**

**4. Fuel level:**

- The fuel level is indicated as a percentage (%) on the bar to the right of the display.

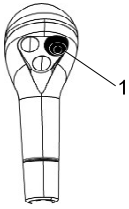
When only the lowest step on the bar is filled, there is 10% of the fuel remaining in the tank and the warning lamp for the fuel level (6) lights.



Press one of the buttons (7) on the far right of the panel. An arrow (8) will then appear on the display.

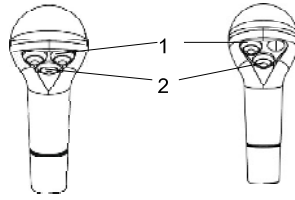
Press the uppermost button (7) and the submenu is displayed.

If the lowermost button (7) on the panel is pressed, AVC (9) is activated and the symbol in the bottom right of the display lights.



*Standard equipped machine.*

*Fig. Forward/Reverse lever right  
1. Vibration on/off*



*Machine with dual controls (option).*

*Fig. Dual forward/reverse lever  
1. Vibration on/off, front drum  
2. Vibration on/off, rear drum*



**Working mode - Edge cutter**



The different working modes are selected with the help of the working mode button on the panel.

**2. Direction of travel**

- The icon has three options (F, N, R) and is shown in the top left of the display.

- **N** (Neutral) shows that the control lever is in the neutral position and no travel direction arrow is shown on the display.

- **F** (Forwards) an arrow directed left is shown in front of "F" on the display.

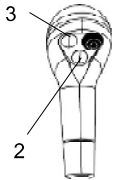
- **R** (Backwards) an arrow directed right is shown after "R" on the display.

**3. Fuel level:**

- The fuel level is indicated as a percentage (%) on the bar to the right of the display.

When only the lowest step on the bar is filled, there is 10% of the fuel remaining in the tank and the warning lamp for the fuel level (6) lights.

*Fig. Working mode, Edge cutter*



*Working mode, Edge cutter*

*Fig. Forward/Reverse lever right  
2. Edge cutter, up  
3. Edge cutter, down*



**Working mode - Chip spreader**

The different working modes are selected with the help of the button on the panel.

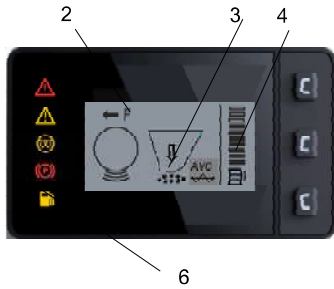


Fig. Working mode, Chip spreader (On)

2. Direction of travel

- The icon has three options (F, N, R) and is shown in the top left of the display.

- **N** (Neutral) shows that the control lever is in the neutral position and no arrow is shown on the display.

- **F** (Forwards) an arrow directed left is shown in front of "F" on the display.

- **R** (Backwards) an arrow directed right is shown after "R" on the display.

3. Chip spreader (off/on)

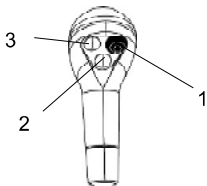
4. Fuel level:

- The fuel level is indicated as a percentage (%) on the bar to the right of the display.

When only the lowest step on the bar is filled, there is 10% of the fuel remaining in the tank and the warning lamp for the fuel level (6) lights.

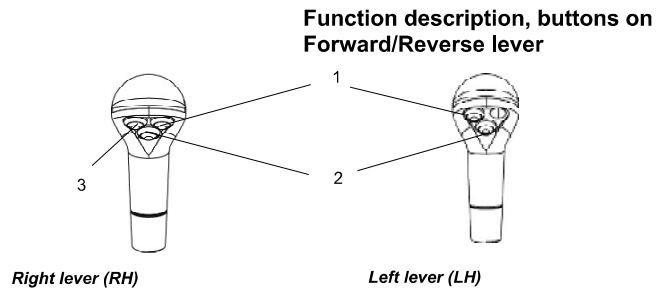


Fig. Working mode, Chip spreader (Off)



Working mode, chip spreader

Fig. Forward/Reverse lever right  
1. Vibration front drum, on/off  
2. Spreader, on/off



Mode / Button	LED	Button 1	Button 2	Button 3
Transport mode	0	None	None	Edge cutter, up
Working mode	1	Vibration, front	Vibration, rear	Edge cutter, up
Edge cutter mode	2	Vibration, front	Edge cutter, down	Edge cutter, up
Spreader mode	3	Vibration, front	Spreader	Edge cutter, up

### Function description - Regeneration

Any of the symbols beside, can be launched in the same spot in the display.

**Note:** To initiate and complete the regeneration engine coolant temperature have to be > 65° C.

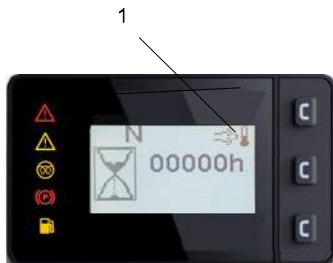



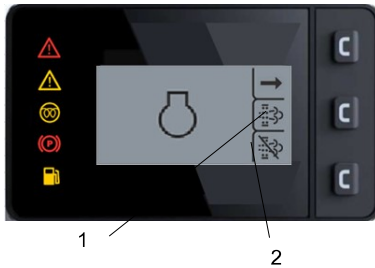


Fig. Display  
1. Symbol

No	Symbol	Designation and Function
1.		<p><b>Parked / Forced regeneration is required</b></p> <p>Park the machine, place FNR lever in Neutral position and parking brake switch engaged. Enter regeneration menu and start a parked regeneration.</p>
2.		<p><b>Imply that a regeneration is ongoing and as a result the exhaust temperature is increased</b></p> <p>Leave the machine running until the symbol disappears.</p>
3.		<p><b>For some reason the regeneration was aborted</b></p> <p>Restart the machine, enter regeneration menu and start a parked regeneration.</p>





**Fig. Sub-menu, Regeneration**

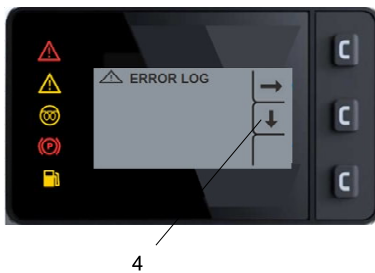
**Sub-menu - Regeneration  
(only D1803 T4f, T5 (28 kW))**

The menu is accessed from the active Home mode.

1. Regeneration is possible to perform when the symbol (1) lights.
  - The side menu is displayed, when the sub-menu is selected.
  - Now go to the Alarm sub-menu.
2. Regeneration is NOT possible to perform when the symbol (2) lights.
  - The side menu is displayed, when the sub-menu is selected.
  - Now go to the Alarm sub-menu.

3. The active Home mode is shown when the travel direction is changed.

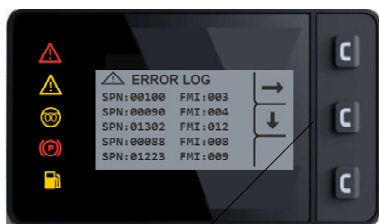
4. If the sub-menu is inactive for more than 20 seconds, the menu will switch back to the active start menu (Transport/Working mode).



**Fig. Sub-menu, Alarm**

**Sub-menu - Alarm**

1. The alarm symbols are shown on the left hand side of the display. At the top is the red warning symbol and at the bottom the yellow.
2. The side menu is displayed, when the sub-menu is selected.



4

*Fig. Sub-menu, Error code list*

3. Now go to the User settings sub-menu.

4. The middle button (4) on the side menu shows a downward arrow. When this is selected, an error code list appears.

When the last error code is shown, scroll the list up to the first error code again.

5. The active Home mode is shown when the travel direction is changed.

6. If the sub-menu is inactive for more than 20 seconds, the menu will switch back to the active home menu.



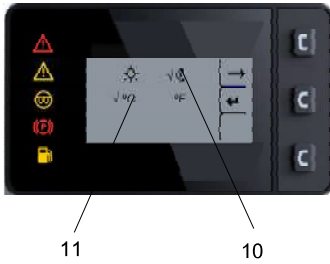
7. When "OK" is shown in the box to the bottom right, the screen should be cleared.

8. When "OK" is selected, the active Home mode is shown.

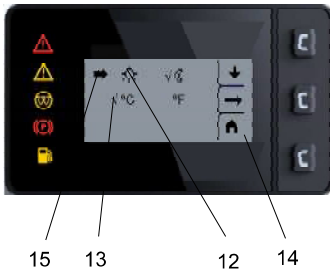
9. A Red or Yellow control lamp gives a reminder until the error is rectified.

**User settings**

Users can change the light settings (10), choose between the Metric or Imperial system (11), and set warning sounds on/off (12).

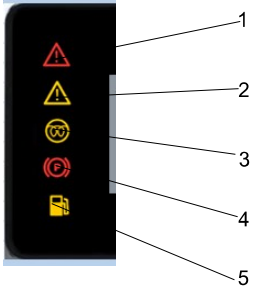







**Fig. User settings**  
10. Light settings  
11. Metric / Imperial unit



**Fig. User settings**  
12. Sound setting  
13. Toggle selector  
14. Home mode  
15. Cursor

### Function description - Alarm



No	Symbol	Designation and Function
1.		Warning lamp (Red)
		Serious fault: <b>Switch off engine immediately!</b> Launched together with a message on the display.
2.		Warning lamp (Yellow)
		Less serious fault: Rectify as soon as possible. Launched together with a message on the display.
3.		Glowing (Yellow) The symbol must go out before the ignition key is moved to position II, for activation of the starter motor.
4.		Parking brake indicator (Red)
		The symbol lights when the parking brake is activated.
5.		Fuel level (Yellow) The symbol lights when there is 10% fuel remaining in the fuel tank.

### Electrical system

#### Fuses

The figure shows the position of the fuses.

The table below gives fuse amperage and function. All fuses are flat pin fuses.

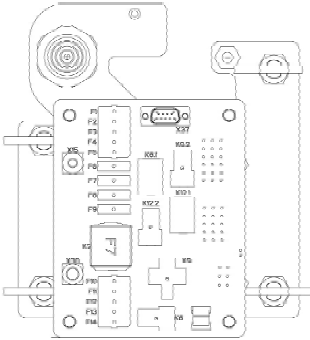


Fig. Fuse box

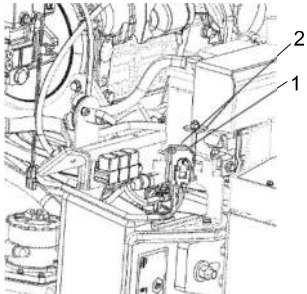
#### Fuse box

1.	F1	ECU	15A	9.	F8	Sprinkler	10A
2.	F2	ECU	7.5A	10.	F9	Sprinkler (Combi)	10A
3.	F3	Display, Membrane panel, Park brake	5A	11.	F10	Ignition key	5A
4.	F4	Joystick Push Bottom, Seat switch	5A	12.	F11	Power outlet	10A
5.	F5	T3 Fuel pump, Generator	3A	13.	F12	ECU	0.5A
6.	F5	T4f, T5 Fuel pump, Generator, Engine sensor	3A	14.	F13	Driving lights, direction indicator	10A
7.	F6	Working lights ROPS or Water tank with 2 lights assembled	10A	15.	F14	Driving lights, Low beam	15A
8.	F7	Working lights frame	15A				

### Fuses at battery master disconnect switch

The figure shows the different positions of the fuses in the engine compartment.

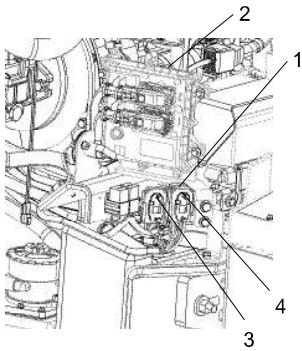
The table below gives fuse amperage and function. All fuses are flat pin fuses.



**Fig. Battery disconnect and fuses (D1703)**

#### D1703

1.	F8	Main fuse	40A
2.	F14	Glowing, Start relay, Fuel solenoid	50A



**Fig. Battery disconnect and fuses (D1803)**

#### D1803

1	F8	Main fuse	40A
2	F13	Engine ECU	50A
3	F14	Starting	50A
4	F20	Glowing	50A

Relays on machine

Engine compartment (D1703)

- 1. K1 Starting
- 2. K3 Fuel solenoid
- 3. K5 Glowing / Preheater

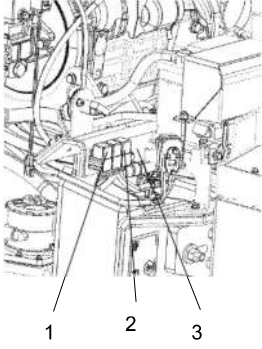


Fig. Relays Engine compartment (D1703)

Engine compartment (D1803)

- 1. K1 Start relay
- 2. K3 Engine ECU relay
- 3. K5 Glowing relay

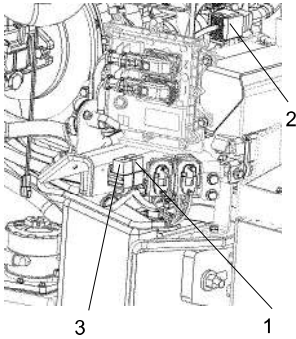
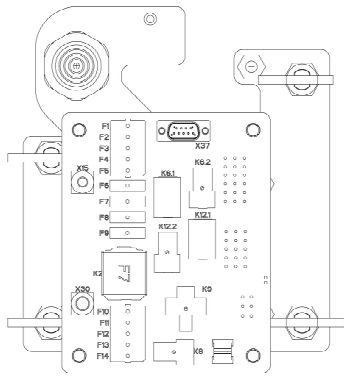


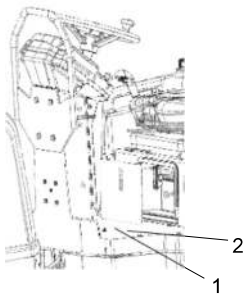
Fig. Relays Engine compartment (D1803)



### Steering column

- |    |       |                                     |
|----|-------|-------------------------------------|
| 1. | K2    | ECU                                 |
| 2. | K6.1  | Working lights frame                |
| 3. | K6.2  | Working lights ROPS or Water tank   |
| 4. | K8    | Driving lights                      |
| 5. | K9    | Driving lights, direction indicator |
| 6. | K12.1 | Sprinkler                           |
| 7. | K12.2 | Sprinkler (Combi)                   |

**Fig. Relays in steering column**



**Fig. Operator's station**  
**1. Control unit (ECU)**  
**2. Floor plate**

The control unit (ECU) (1) is located under the floor plate (2) on the platform.

This control unit manages, among others, automatic vibration control, automatic watering control and interlock.



## Operation

### Before starting

#### Master switch - Switching on

Remember to carry out daily maintenance. See the maintenance instructions.

The battery disconnecter is on the left side in the engine compartment.  
Turn the key (1) to switched on position. The roller is now supplied with power.

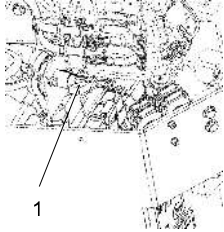


Fig. Engine compartment  
1. Battery disconnecter



***The engine hood must be unlocked during operation, unless the battery disconnecter is freely accessible from the outside, so that the battery voltage can be quickly disconnected if necessary.***

**Driver seat - Adjustment**

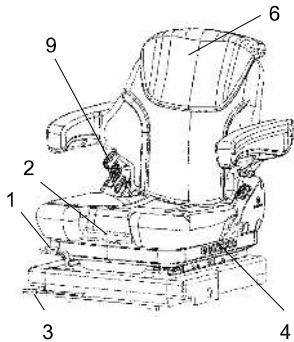
Adjust the operator's seat so that the position is comfortable and so that the controls are within easy reach.

The tables below show the adjustments that can be made on the different seats.

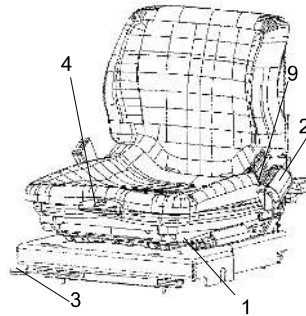
The image below to the left shows a fully equipped luxury comfort seat while the image below to the right shows a normally equipped comfort seat.

**⚠ Always make sure that the seat is secure before beginning operation.**

**⚠ Remember to use the seat belt (9).**

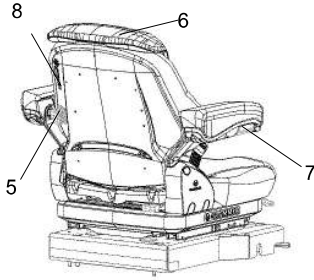


**Fig. Driver seat (MSG65)**  
 1. Locking lever - Length adjustment  
 2. Weight adjustment  
 4. Backrest inclination  
 9. Seat belt



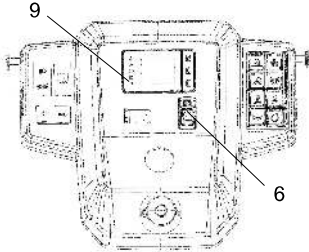
**Fig. Driver seat (MSG20)**  
 1. Locking lever - Length adjustment  
 2. Weight adjustment  
 4. Backrest inclination  
 9. Seat belt

	Length adjustment (1)	Weight adjustment (2)	Side travel (3)	Backrest inclination (4)
Standard seat	x			
Comfort seat	x	x	(Optional)	x
Luxury comfort seat	x	x	(Optional)	x



**Fig. Driver seat (MSG65)**  
5. Lumbar support adjustment  
6. Backrest extension  
7. Armrest, adjustable  
8. Seat heating

	Lumbar support adjustment (5)	Backrest extension (6)	Armrest, adjustable (7)	Seat heating (8)
Standard seat				
Comfort seat				
Luxury comfort seat	X	X	X	X



**Fig. Instrument panel**  
6. Parking brake  
9. Brake warning lamp

**Parking brake - Check**

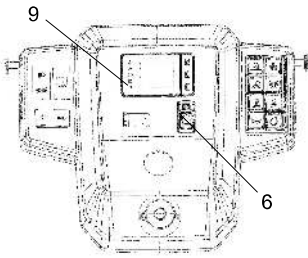


**Make sure that the parking brake (6) is activated. The roller can start to roll if the parking brake is not applied.**



**Check the function of the parking brake by activating the parking brake when the roller is moving very slowly forwards/backwards. (Check in both directions). Hold the steering wheel and brace yourself for a sudden stop when the brakes are activated. The engine does not switch off.**

**!** *The engine can only be started with the parking brake (6) activated.*



*Fig. Instrument panel*  
6. Parking brake  
9. Brake warning lamp

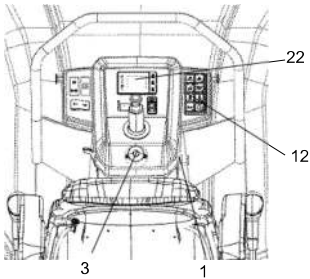
### Reserve brake - Control

Drive slowly forwards/backwards and press down the parking brake button (6) to activate it.

The roller must now stop immediately.

### Instruments and lamps - Checking

**!** *Make sure that the emergency stop button is pulled out and the parking brake is activated.*



*Fig. Instrument panel*  
1. Ignition key  
3. Emergency stop  
12. Sprinkler activation button  
22. Display

Turn the ignition key (1) to position 2.

Check that the warning symbols are shown on the display (22).

Activate the front sprinker button (12) to the operating position, and check that the system works.

**Interlock**

The roller is equipped with Interlock.

The diesel engine with switch off after 4 seconds if the operator gets off the seat when going forwards/backwards.

If the control is in neutral when the operator stands up a buzzer will go on until the parking brake button is activated.

If the parking brake remains inactive, the diesel engine turns off after 4 seconds.

The engine does not stop if the parking brake is activated.

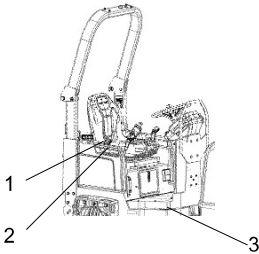
The diesel engine will switch off immediately if for any reason the forward/reverse lever is moved out of neutral when the operator is not sitting down and the parking brake button has not been activated.



**Sit down for all operations!**

**Operator position**

If a ROPS (Roll Over Protective Structure) is fitted to the roller, always wear the seat belt (1) and wear a protective helmet.



**Fig. Operator's station**

1. Seat belt

2. Safety railing

3. Rubber element



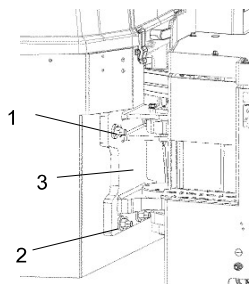
**Always replace the seat belt (1) if it shows signs of wear or has been subjected to excessive strain.**



Check that the platform's rubber elements (3) are in good condition. If the elements are worn this will have a negative effect on comfort.



**Ensure that the platform floor is clean to avoid the risk of slipping.**



**Fig. Articulated joint**  
1. Nut  
2. Washer  
3. Articulated joint holder

### Adjusting the Off-set

Lift up the front drum just above ground level.

Place a jack on the rear frame, to support the articulated joint, and loosen the nuts on the articulated joint (1).

Position yourself on the right or left-hand side of the articulated joint.

Use the requisite tools (for example, a rubber covered steel bar) and hit the articulated joint holder (3). The articulated joint holder now moves sideways.

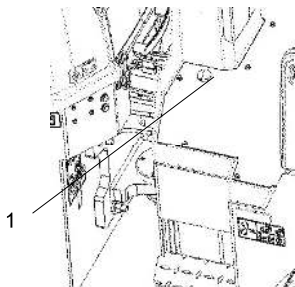
When the adjustment is made, make sure to tighten the nuts on the articulated joint (1) to the right torque again.

### Flow divider (Optional)

The switch on the floor (to the left) must be pressed down to activate the flow divider.

The flow divider is enabled as long as the switch is actuated.

Remove your foot from the switch to disable the flow divider.



**Fig. Operator platform**  
1. Flow divider switch

## Starting

### Starting the engine

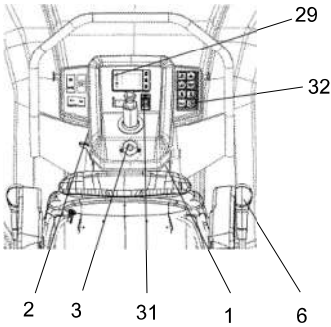


Fig. Control panel

- 1. Ignition key
- 2. Engine speed control (D1703)
- 3. Emergency stop
- 6. Forward/reverse lever
- 29. Glow lamp
- 31. Parking brake
- 32. Engine speed selector (D1803)



**The operator must remain seated when starting.**

Make sure that the emergency stop (3) is pulled out and the parking brake (31) is activated.

Set the forward/reverse lever (6) in neutral. The engine can only be started when the lever is in neutral.



**Do not run the starter motor for too long. If the engine does not start, wait a minute or so before trying again.**

#### D1703

At high ambient temperatures, set the engine speed control (2) to the position just over idling.

On cold start, set the engine speed control to medium revs. Preheating: Turn the ignition key to position II. When the glow lamp (29) goes out: Turn the ignition key (1) to the right. As soon as the engine starts, release the ignition key and reduce the engine speed to just over idling (because high revs can damage a cold engine). As soon as the engine is running smoothly, reduce the revs down to idling.

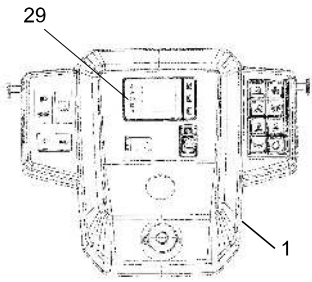
#### D1803

Make sure that the LED button (32) is set to LOW mode (1 lamp lit).

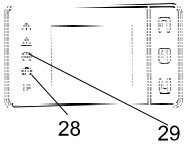
Warm up the engine at idling speed for a few minutes, although longer if ambient temperature is below +10°C (50°F).



**If the parking brake is not activated and the forward/reverse lever is in neutral, the parking brake and jump start symbols will be lit on the display.  
The machine cannot be started.**



**Fig. Instrument panel**  
1. Ignition key  
29. Glow lamp



**Fig. Control panel**  
25. Parking brake lamp  
29. Glow lamp

Check while warming up the engine that no warning lamps are lit.

The parking brake lamp (25) will remain on for as long as the parking brake switch is activated.



**When starting and driving a machine that is cold, remember that the hydraulic fluid is also cold and that braking distances can be longer than normal until the machine reaches the working temperature.**



**Ensure that there is good ventilation (air extraction) if the engine is run indoors. Risk of carbon monoxide poisoning.**



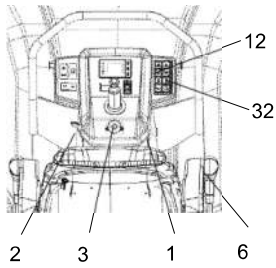


Fig. Instrument panel

- 1. Ignition key
- 2. Engine speed control (D1703)
- 3. Emergency stop
- 6. Forward/reverse lever
- 32. Engine speed selector (D1803)

## Driving

### Operating the roller



**Under no circumstances is the machine to be operated from the ground. The operator must be seated inside the machine during all operation.**



**Make sure that the area in front of and behind the roller is clear.**

Release the parking brake and check that the parking brake lamp goes off.

#### D1703

Turn the throttle control (2) in backward position.

#### D1803

Press the LED button (32) so it is in LOW mode (1 lamp lit).

Check that the steering is working correctly by turning the steering wheel once to the right and once to the left while the roller is stationary.

When compacting asphalt, remember to enable the sprinkler system (12).

**Interlock/Emergency stop/Parking brake -  
Check**

*The interlock, emergency stop and parking brake must be checked daily before operating. A function check of the interlock and emergency stop requires a restart.*



*The interlock function is checked by the operator standing up from the seat when the roller is moving very slowly forwards/backwards. (Check in both directions). Hold the steering wheel firmly and brace yourself for a sudden stop. A buzzer goes on and after 4 seconds the engine switches off and the brakes are activated.*

*If malfunction is detected during emergency stop testing, replace it immediately with a new one.*



*Check the function of the emergency stop by pressing the emergency stop when the roller is moving slowly forwards/backwards. (Check in both directions). Hold the steering wheel firmly and brace yourself for a sudden stop. The engine switches off and the brakes are activated.*



*Check the function of the parking brake by activating the parking brake when the roller is moving very slowly forwards/backwards. (Check in both directions). Hold the steering wheel and brace yourself for a sudden stop when the brakes are activated. The engine does not switch off.*

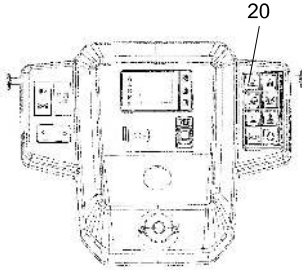


Fig. Instrument panel  
20. Edge cutter/compactor, Up/Down

### Edge cutting (Optional)

The machine must be running to activate the edge cutter/compactor.

With the machine in **Working mode/Edge cutter** (20) (middle LEDs lit) the edge cutter/compactor is controlled up and down with the help of button (3) and button (2) on the control lever.

The edge cutter/compactor can always be moved upwards, irrespective of the position selected on the button **Working mode** (20). Also in **Transport mode** (0 LEDs lit) the edge cutter/compactor can be moved upwards, with button (3).

A bypass valve prevents the hydraulic system being overloaded.

The operator should use the ordinary sprinkler system to avoid asphalt sticking to the edge cutter/compactor, and open the ball valve (5) by the separate sprinkler nozzle on the edge cutter/compactor.

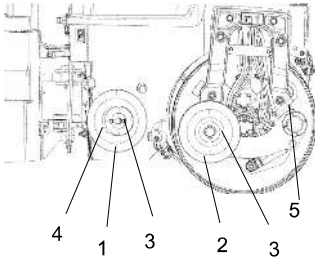


Fig. Changing tools  
1. Edge compactor  
2. Edge cutter  
3. Bolted joints  
4. Holder for cutter/compactor wheel  
5. Ball valve

The operator can choose between two tools, the edge cutter or edge compactor. The edge cutter (1) in the figure is shown in the operating position. The edge compactor (2) can easily be replaced with the edge cutter by releasing the bolted joint (3).

## Vibration

### Manual/Automatic vibration

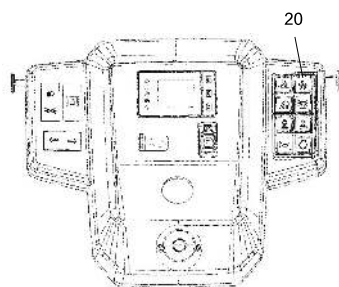


Fig. Instrument panel  
20. Switch, Vibration selector

In **Working mode/Vibration** (20) (LED LEFT lit) you can select, manually, which drum is to vibrate with the button on the forward/reverse lever.

For Standard machine:

Button (1) activates vibration on **on both** the drums.

For machines equipped with options:

Button (1) activates vibration on **the front** drum.

Button (2) activates vibration on **the rear** drum.

Both buttons activate vibration on **on both** the drums.

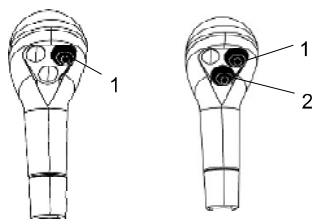
In automatic mode, the vibration is activated when the pre-set speed is reached, provided that one or both drums are selected with the help of the buttons on the control lever.

(See the Display chapter to active).

Vibration is automatically deactivated when the lowest pre-set speed is reached.

Deactivation is performed by pressing one or both of the buttons (1 and 2) again.

**If the machine is in Transport mode and the buttons on the forward/reverse lever are pressed, the Working mode symbol is shown on the display.  
The three LEDs on the Working position button flash.**



Standard equipped machine    The machine is equipped with options  
Fig. Right Forward/Reverse lever

## Braking

### Normal braking

Turn off the vibration using the buttons (1) and (2) on the control lever.

Move the forward/reverse lever (6) to the neutral position to stop the roller.

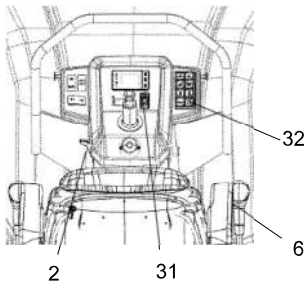


Fig. Control panel  
 2. Engine speed control (D1703)  
 6. Forward/reverse lever  
 31. Parking brake  
 32. Engine speed selector (D1803)



**When starting and driving a machine that is cold, remember that the hydraulic fluid is also cold and that braking distances can be longer than normal until the machine reaches the working temperature.**



**Never leave the operator platform without activating the parking brake (31).**

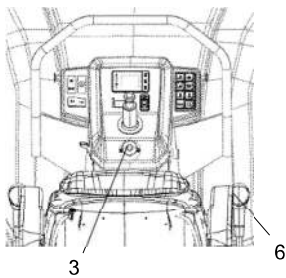


Fig. Control panel  
 3. Emergency stop  
 6. Forward/Reverse lever

### Emergency braking

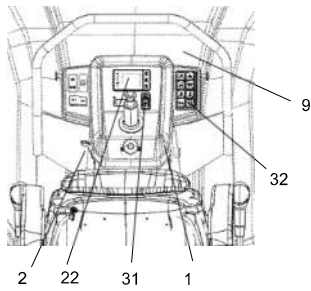
Braking is normally activated using the forward/reverse lever (6). The hydrostatic transmission brakes the roller when the lever is moved to the neutral position.

There is a brake on each drum motor that acts a secondary brake when in motion, and as a parking brake when stationary.



**To brake in an emergency situation, push in the emergency stop (3), hold the steering wheel firmly and be prepared for a sudden stop. The diesel engine stops.**

After emergency braking, reset the forward/reverse lever (6) to neutral position, pull out the emergency stop and activate the parking brake. Restart the engine.



**Fig. Instrument panel**

- 1. Ignition key
- 2. Engine speed control (D1703)
- 9. Instrument cover
- 22. Panel for warning lamps
- 31. Parking brake
- 32. Engine speed selector (D1803)

### Switching off

Activate the parking brake (31).

#### **D1703**

Turn the engine speed control (2) back to idling.

#### **D1803**

Press the LED button (32) so it is set to LOW mode (left LED lit).

Allow the engine to idle for a few minutes to cool down.

Check instruments and warning lamps to see if any faults are indicated. Switch off all lights and other electrical functions.

Turn the ignition key (1) to the left to the switched off position. At the end of the shift, fold over the instrument cover (9) and lock.

## Parking

### Chocking the drums



*Never disembark from the roller when the diesel engine is running, without first activating the parking brake.*



*Make sure that the roller is parked in a safe place with respect to other road users. Chock the drums if the roller is parked on sloping ground.*



Remember that there is a risk of freezing during the winter. Empty the water tank. Fill antifreeze in the engine's cooling system. See also maintenance instructions.

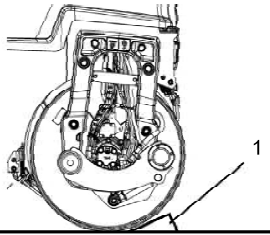


Fig. Drum part  
1. Chocks

### Battery disconnecter

Before leaving the roller at the end of the shift, switch off the battery disconnecter (1) and remove the key.

This will prevent battery discharging and will also make it difficult for unauthorized persons to start and operate the machine. Lock also the engine cover.

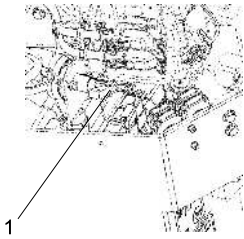


Fig. Battery compartment  
1. Battery disconnecter





**Long-term parking**

 The following instructions should be followed when long term parking (more than one month).



*Fig. Roller weather protection*

These measures apply when parking for a period of up to 6 months.

Before re-commissioning the roller, the points marked with an asterisk \* must be returned to the pre-storage state.

Wash the machine and touch up the paint finish to avoid rusting.

Treat exposed parts with anti-rust agent, lubricate the machine thoroughly and apply grease to unpainted surfaces.

**Engine**

\* Refer to the manufacturer's instructions in the engine manual that is supplied with the roller.

**Battery**

\* Dismantle the battery/batteries from the machine, clean the outside and maintenance charge.

**Air cleaner, exhaust pipe**

\* Cover the air cleaner or its opening with plastic or tape. Also cover the exhaust pipe opening. This is to avoid moisture entering the engine.

**Fuel tank**

Fill the fuel tank completely full to prevent condensation.

**Hydraulic reservoir**

Fill the hydraulic reservoir to the uppermost level mark (see under the heading 'Every 10 hours of operation.')

### **Steering cylinder, hinges, etc.**

Lubricate the steering joint bearings and the steering cylinder's two bearings with grease.

Grease the piston rod of the steering cylinder with inhibitor grease.

Grease the hinges on the engine compartment hood and also grease both ends of the forward/reverse control (bright parts).

### **Watering system**

\* Empty the water tank and all hoses of water. Empty the filter housing and the water pump. Undo all sprinkler nozzles.

### **Hoods, tarpaulin**

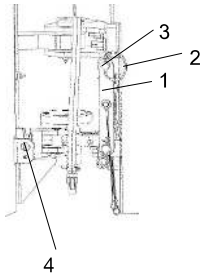
\* Lower the instrument cover over the instrument panel.

\* Cover the entire roller with a tarpaulin. A gap must be left between the tarpaulin and the ground.

\* If possible, store the roller indoors and ideally in a building where the temperature is constant.

**Miscellaneous****Lifting****Locking the articulation**

*Articulation must be locked to prevent inadvertent turning before lifting the roller.*



**Fig. Articulation in the locked position**

- 1. Locking arm**
- 2. Locking pin**
- 3. Locking stud**
- 4. Locking lug**

Turn the steering wheel to the straight ahead position.  
Enable the parking brake.

Pull out the locking pin (2) fitted with a wire, and pull up/out the locking dowel (3).

Fold out the locking arm (1) and secure it to the upper locking lug (4) on rear frame.

Fit the locking stub (3) in the holes through the locking arm (1) and locking lug (4) and secure the stud in position with the locking pin (2).

Weight: see the machine plate on the roller

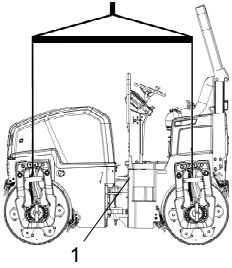


Fig. Four-point lift of the roller  
1. Machine plate

**Lifting the roller**

**!** The maximum weight of the machine (5) can be read on the machine plate (1).

**!** Lifting equipment such as chains, steel wires, straps and lifting hooks must be dimensioned in accordance with the relevant safety regulations for the lifting equipment.

**!** Stand well clear of the hoisted machine! Make sure that the lifting hooks are properly secured.

**!** The machine must not be lifted with chips in the chip spreader.

Dynapac Compaction Equipment AB Box 504, SE-371 23 Karlskrona Sweden					
Product Identification Number		XXXXXXXXXXXXXXXXXXXX			
Designation	Type	Rated Power	Max. net load front / rear kg		
XXXXXX	XXXXXX	XXX kW	XXX/XXX		
Gross machinery mass	Operating mass	Max. balast	Date of Mfg.		
XXXX kg	XXXX kg	XXXX kg	XXXX		
Made in Sweden <small>© 1999-2015</small>					

5

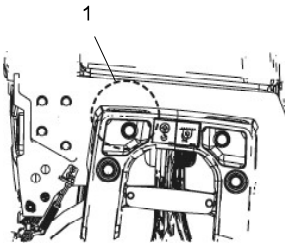


Fig. Two-point lift of the roller - Rear forks  
1. Location of the lifting hook

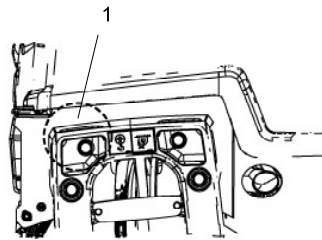


Fig. Two-point lift of the roller - Front forks  
1. Location of the lifting hook

2

1

Fig. Single -point lift of the roller  
1. Machine plate  
2. Location of the lifting hook

**Lifting the roller with a single -point lift  
(Optional)**



**The maximum weight of the machine (5) can be read on the machine plate (1).**



Lifting equipment such as chains, steel wires, straps and lifting hooks must be dimensioned in accordance with the relevant safety regulations for the lifting equipment.






**Stand well clear of the hoisted machine! Make sure that the lifting hooks are properly secured.**



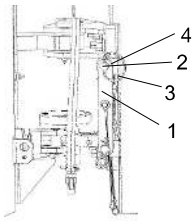
**The machine must not be lifted from the ROPS, (Roll Over Protective Structure) if the machine is not equipped with a single-point lift.**



**The machine must not be lifted from the single-point lift if the machine is equipped with a chip spreader.**

		 Dynapac Compaction Equipment AB Box 504, SE-371 23 Karlskrona Sweden		
Product Identification Number		XXXXXXXXXXXXXXXXXXXX		
Designation	Type	Rated Power	Max. axle load front / rear	
XXXXXX	XXXXXX	XXX kW	XXXXXXX kg	
Gross machinery mass	Operating mass	Max ballast	(Date of Mfg)	
XXXX kg	XXXX kg	XXXX kg	XXXX	
Made in Sweden <small>© 2019 Dynapac AB</small>				

5



**Fig. Articulation in the open position**  
1. Locking arm  
2. Locking pin  
3. Locking stud  
4. Locking lug

### Unlocking the articulation



Remember to unlock the articulation before operating.

Fold the locking arm (3) back and secure it in the locking lug (4) with the stud (3). Insert the locking pin (2) fitted with a wire, to secure the stud (3). The locking lug (4) is located on the front frame.

### Towing/Recovering

The roller can be moved up to 300 meters (330 yards) using the instructions below.

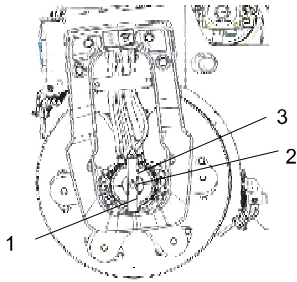


Fig. Left side of drum  
1. Brake tool  
2. Fastening screw  
3. Disengagement nut

### Release the brakes



**Activate the parking brake, and stop the engine. Block the drum with a chock to prevent movement; the roller can start rolling when the brakes are released.**



The disc brake in each drive motor must be disengaged mechanically, according to below following instructions, before the roller can be towed.

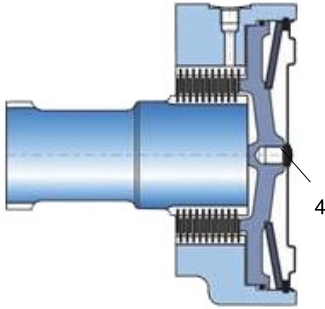


Fig. Brake housing  
4. Center plug

Remove the center plug (4) using a screwdriver.


Screw off the brake tool (1) from its threaded fixing hole. Then fix the brake tool (1) in the center hole by tightening the screw (2) until it bottoms in the hole. Tighten the nut (3) against the brake tool until it stops, indicating that the brakes is now disengaged.

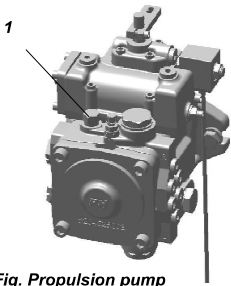
Tightening torque: 42 Nm (31 lb.ft)

### Disengaging the brakes

Screw out the nut again after towing. This returns the brakes to their normal mode. Screw off the brake tool and fit it back into its fixing holes. Refit the center plug (4) to counteract the information of rust inside the threaded hole.

Short distance towing with switched off engine

 **Check the drums to prevent the roller from moving.**



**Fig. Propulsion pump**  
**1. By-pass screw**

Open the hood and make sure that the propulsion pump is accessible.

There is a bypass screw (1) located on the pump that must be unscrewed counterclockwise (max two turns), to put the drive system (ports A and B) in bypass mode.

This function enables a machine to be moved without the drive shaft on the propulsion pump rotating.

Turn the bypass screw (1) clockwise to reset.



**Towing the roller**



**The roller must be counter-braked during towing/recovery. Always use a towbar. There is no braking capacity on the roller now.**



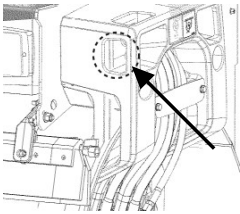
**The roller must be towed slowly, max. 3 kph (2 mph) and only towed short distances, max. 300 m (1000 ft).**

**Fig. Towing**

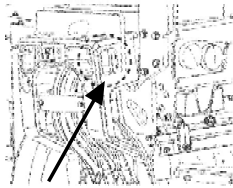
When towing/retrieving a machine, the towing device must be connected to both lifting holes. The pulling force shall act longitudinally on the machine as shown in the figure. Maximum total pulling force 39,7 kN (8925 lbf).



**Reverse the towing preparations.**



**Fig. Bracket, towing - front**



**Fig. Bracket, towing - rear**

### Transport

Tie-down and secure the machine according to the Cargo Securing Certificate for the specific machine if this is available and applicable.

If not, tie down and secure the machine according to the cargo securing rules that are valid for the country where the transport takes place.



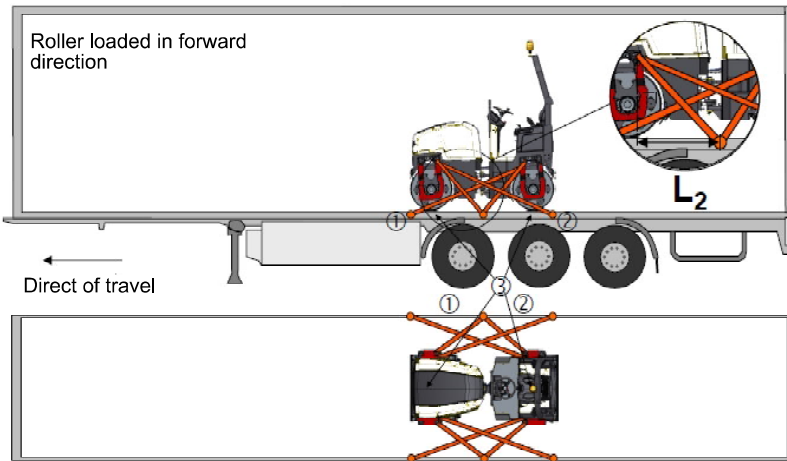
***Never lash over the machine's articulated joint, nor over the machine's operator platform.***

Before securing the machine ensure that :

- the parking brake is applied and in good working condition
- the articulated joint is in closed position
- the machine is centered laterally on the platform
- the lashings are in good condition and fulfills the corresponding rules for transport securing.

**Securing CC1100 VI / CC1200 VI for loading**

Securing the CC1100 VI / CC1200 VI vibratory roller from Dynapac for transport.



- 1 - 2 = double lashings, i.e. one lashing with two parts secured to two different lashing mounts on the trailer, symmetrically located on the right and left sides.
- 3 = rubber

The lashings' permitted distance interval in meters		
(1 - 2: Double lashings, LC at least 1.7 tonnes (1700 daN), S <sub>TF</sub> 300 kg (300daN))		
Double L <sub>1</sub>	Double L <sub>2</sub>	
0.1 - 2.5	0.4 - 2.5	

*L<sub>2</sub> is the distance between the lashing point on the edge of the platform and the point directly sideways from the lashing point on the roller perpendicular to the platform edge for lashing 2. The relationship for L<sub>1</sub> is the same.*

**Load carrier**

- Ensure that:
- When loaded, the vibratory roller is centered laterally on the platform ( $\pm 5$  cm).
  - The parking brake is applied and in good working condition, and the articulated joint lock is closed.
  - The drum is placed on a rubber liner, so that the static friction between the surfaces is at least 0.6.

- The contact surfaces must be clean, wet or dry, and free from frost, ice and snow.
- The lashing mounts on the load carrier have LC/MSL at least 2 tonnes.

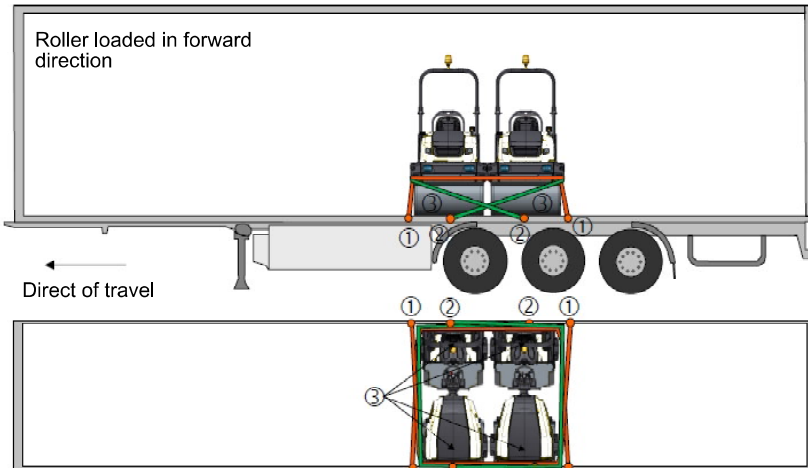
**Lashings**

Ensure that:

- The lashings comprise a lashing strap or chain with a permitted load (LC/MSL) of at least 1.7 tonnes (1,700 daN) and a pre-tension  $S_{TF}$  of at least 300 kg (300 daN). The lashings are re-tightened as required.
- Each of lashings 1-2 is either a double or two single lashings. A double lashing runs in a sling through a lashing point or around a machine part and down into two different mounts on the platform.
- Lashings in the same direction are placed in different lashing mounts on the trailer. Lashings that are pulled in opposite directions may be placed in the same lashing mount, however.
- The lashings are as short as possible.
- The lashing hooks must not lose grip if the lashings become slack.
- The lashings are protected against sharp edges and corners.
- The lashings are located symmetrically in pairs on the right and left sides.

**Securing CC1100 VI / CC1200 VI for loading  
(Side across the trailer)**

Securing the CC1100 VI / CC1200 VI vibratory roller from Dynapac for transport.



- 1 = two sling straps, one directed to the right and one to the left, which are attached on the platform as close to the rollers as possible. LC at least 1.7 tonnes (1700 daN), S<sub>TF</sub> at least 300 kg (300 daN)
- 2 = two spring lashings; one directed forward and one backward. LC at least 1.7 ton (1700 daN), S<sub>TF</sub> at least 300 kg (300 daN)
- 3 = rubber

The lashings' permitted distance interval in meters		
(1 - 4: Double lashings, LC at least 1.7 tonnes (1700 daN), S <sub>TF</sub> 300 kg (300daN))		
Double L <sub>1</sub> - L <sub>2</sub>	Double L <sub>3</sub> - L <sub>4</sub>	
0,6 - 3,0	0,1 - 3,0	

*L<sub>2</sub> is the point directly at right angles laterally in relation to the edge of the platform from the lashing mount on the roller for lashing 2. L<sub>1</sub> for lashing 1 has a corresponding relationship.*

**Load carrier**

Ensure that:

- When loaded, the vibratory roller is centered laterally on the platform ( $\pm 5$  cm).
- The parking brake is applied and in good working condition, and the articulated joint lock is closed.
- The drum is placed on a rubber liner, so that the static friction between the surfaces is at least 0.6.
- The contact surfaces must be clean, wet or dry, and free from frost, ice and snow.
- The lashing mounts on the load carrier have LC/MSL at least 2 tonnes.

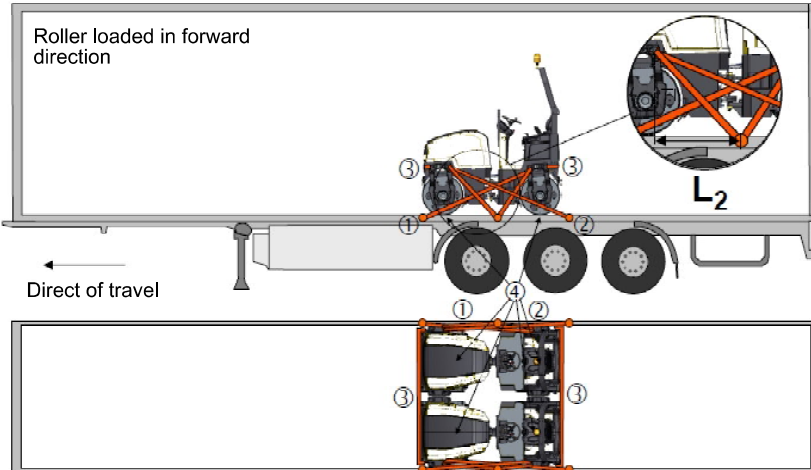
**Lashings**

Ensure that:

- The lashings comprise a lashing strap or chain with a permitted load (LC/MSL) of at least 1.7 tonnes (1,700 daN) and a pre-tension  $S_{TF}$  of at least 300 kg (300 daN). The lashings are re-tightened as required.
- The lashings are placed in different lashing points in the trailer. Lashings drawn in opposite directions are allowed to be attached to the same lashing point.
- Lashings securing the rollers sideways; the hooks are placed as close to the rollers as possible on the platform to not steal space for any other cargo.
- The lashing hooks must not lose grip if the lashings become slack.
- The lashings are protected against sharp edges and corners.

**Securing CC1100 VI / CC1200 VI for loading  
(Side along the trailer)**

Securing the CC1100 VI / CC1200 VI vibratory roller from Dynapac for transport.



- 1 - 2 = double lashings, i.e. one lashing with two parts secured to two different lashing mounts on the trailer. Symmetrically located on the right and left sides.
- 3 = the two rollers are tied together to one unit.
- 4 = rubber

The lashings' permitted distance interval in meters		
(1 - 2: Double lashings, LC at least 1.7 tonnes (1700 daN), S <sub>TF</sub> 300 kg (300daN))		
Double L <sub>1</sub>	Double L <sub>2</sub>	
0.1 - 2.5	0.7 - 2.5	

*L<sub>2</sub> is the distance between the lashing point on the edge of the platform and the point directly sideways from the lashing point on the roller perpendicular to the platform edge for lashing 2. The relationship for L<sub>1</sub> is the same.*

**Load carrier**

Ensure that:

- When loaded, the vibratory roller is centered laterally on the platform ( $\pm 5$  cm).
- The parking brake is applied and in good working condition, and the articulated joint lock is closed.
- The drum is placed on a rubber liner, so that the static friction between the surfaces is at least 0.6.
- The contact surfaces must be clean, wet or dry, and free from frost, ice and snow.
- The lashing mounts on the load carrier have LC/MSL at least 2 tonnes.

**Lashings**

Ensure that:

- The lashings comprise a lashing strap or chain with a permitted load (LC/MSL) of at least 1.7 tonnes (1,700 daN) and a pre-tension  $S_{TF}$  of at least 300 kg (300 daN). The lashings are re-tightened as required.
- Each of lashings 1-3 is either a double or two single lashings. A double lashing runs in a sling through a lashing point or around a machine part and down into two different mounts on the platform.
- Lashings in the same direction are placed in different lashing mounts on the trailer. Lashings that are pulled in opposite directions may be placed in the same lashing mount, however.
- Lashing 3 ties the two rollers together to one unit. The lashing is drawn from drum to drum or from lashing eye to lashing eye on the front part as well as the rear part of the rollers.
- The lashings are as short as possible.
- The lashing hooks must not lose grip if the lashings become slack.
- The lashings are protected against sharp edges and corners.
- The lashings are located symmetrically in pairs on the right and left sides.



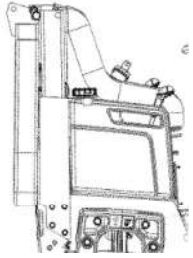


Fig. Retractable ROPS

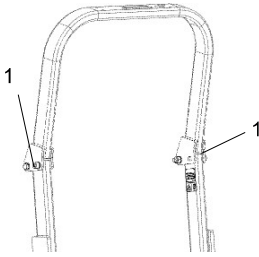


Fig. ROPS locking device  
1. Bolt

### Foldable ROPS

The machine is equipped with foldable ROPS



**Risk of crush injury when raising and lowering ROPS.**



**Always make sure the ROPS is locked in raised position before operation**

When retract the ROPS, loosen the screw (1) and pull it out. Do the same on both sides of the ROPS.



**After lowering the ROPS, replace the screw in its position**

To lift the ROPS proceed in the reverse order.



**Always make sure the ROPS is locked in raised position before operation.**

Grease the screw (1) periodically using water resistant grease.



### Operating instructions - Summary



1. Follow the **SAFETY INSTRUCTIONS** specified in the **Safety Manual**.
2. Make sure that all instructions in the **MAINTENANCE** section are followed.
3. Turn the master switch to the **ON** position.
4. Set the emergency stop in the pulled out position.
5. Move the forward/reverse lever to the **NEUTRAL** position.
6. Set the engine speed control to **MEDIUM**. (**D1703**).  
Set the speed selector to **LOW** (**D1803**).
7. Start the engine and allow it to warm up.
8. Set the engine speed control to the operating position.



9. **Drive the roller. Operate the forward/reverse lever with care.**



10. **Check the brakes, drive slowly. Remember that the braking distance will be longer if the hydraulic oil is cold.**

11. Use vibration only when the roller is in motion.
12. Check that the drums are thoroughly watered when watering is required.



13. **IN AN EMERGENCY:**
  - Press the **EMERGENCY STOP**
  - Hold the steering wheel firmly.
  - Brace yourself for a sudden stop. The engine stops.
14. Parking: - Stop the engine and chock the drums.
15. When lifting: - Refer to the relevant section in the Instruction Manual.
16. When towing: - Refer to the relevant section in the Instruction Manual.
17. When transporting: - Refer to the relevant section in the Instruction Manual.
18. When recovering - Refer to the relevant section in the Instruction Manual.



### Preventive maintenance

Complete maintenance is necessary for the machine to function satisfactorily and at the lowest possible cost.

The Maintenance section includes the periodic maintenance that must be carried out on the machine.

The recommended maintenance intervals assume that the machine is used in a normal environment and working conditions.

### Acceptance and delivery inspection

The machine is tested and adjusted before it leaves the factory.

On arrival, before delivery to the customer, delivery inspection must be conducted as per the check list in the warranty document.

Any transport damage must be reported immediately to the transport company, as this is not covered by the product warranty.


### Warranty

The warranty is only valid if the stipulated delivery inspection and the separate service inspection have been completed as per the warranty document, and when the machine has been registered for starting under the warranty.

The warranty is not valid if damage has been caused by inadequate service, incorrect use of the machine, the use of lubricants and hydraulic fluids other than those specified in the manual, or if any other adjustments have been made without the requisite authorisation.

CALIFORNIA

**Proposition 65**Decal and location of decal shown in section  
Machine description.

 **WARNING:** Breathing diesel engine exhaust exposes you to chemicals known to the State of California to cause cancer and birth defects or other reproductive harm.

- Always start and operate the engine in a well-ventilated area.
- If in an enclosed area, vent the exhaust to the outside.
- Do not modify or tamper with the exhaust system.
- Do not idle the engine except as necessary.

For more information go to [www.P65warnings.ca.gov/diesel](http://www.P65warnings.ca.gov/diesel).








### Maintenance - Lubricants and symbols



Always use high-quality lubricants and the amounts recommended. Too much grease or oil can cause overheating, resulting in rapid wear.

#### Fluid volumes

Hydraulic tank	40 liters	42.3 qts
Diesel engine		
CC1100 VI		
- D1703-M-DI-E4B (T4f, T5)	7 liters	7.4 qts
- D1703-M-IDI-E3 (T3)	7 liters	7.4 qts
- D1803-CR (T4f, T5)	7 liters	7.4 qts
CC1200 VI		
- D1703-M-DI-E4B (T4f, T5)	7 liters	7.4 qts
- D1703-M-IDI-E3 (T3)	7 liters	7.4 qts
- D1803-CR (T4f, T5)	7 liters	7.4 qts
Drum		
- CC1100 VI	6 liters	6.3 qts
- CC1200 VI	7 liters	7.4 qts
Coolant		
- D1703-M-DI-E4B (T4f, T5)	6 liters	6.3 qts
- D1703-M-IDI-E3 (T3)	6 liters	6.3 qts
- D1803-CR (T4f, T5)	6 liters	6.3 qts













	ENGINE OIL	Air temperature -15°C - +50°C (5°F-122°F)	<b>Dynapac Engine Oil 200</b>	P/N 4812161855 (5 liter) P/N 4812161856 (20 liter) P/N 4812161857 (209 liter)
	HYDRAULIC FLUID	Air temperature -15°C - +50°C (5°F-104°F)	<b>Dynapac Hydraulic 300</b>	P/N 4812161868 (20 liter) P/N 4812161869 (209 liter)
	BIOLOGICAL HYDRAULIC FLUID, PANOLIN	Air temperature over +50°C (104°F)  When it leaves the factory, the machine may be filled with biologically degradable fluid. The same type of fluid must be used when changing or topping up.	Shell Tellus S2 V100  PANOLIN HLP Synth 46 (www.panolin.com)	
	DRUM OIL	Air temp. -15°C - +40°C (5°F-104°F)	<b>Dynapac Gear Oil 300</b>	P/N 4812161887 (5 liter) P/N 4812161888 (20 liter) P/N 4812161889 (209 liter)
		Air temperature 0°C - over +40°C (32°F- over 104°F)	Shell Spirax AX 85W/140, API GL-5	
	GREASE		<b>Dynapac Roller Grease</b>	P/N 4812030096 (0.4 kg)
	FUEL	See engine manual.	-	-
	COOLANT	Anti-freeze protection down to about -37°C (-34.6°F)	<b>Dynapac Coolant 100</b> (mixed 50/50 with water)	P/N 4812161854 (20 liter)



Other fuel and lubricants are required when operating in areas with extremely high or extremely low ambient temperatures. See the 'Special instructions' chapter, or consult Dynapac.



### Maintenance symbols

	Engine, oil level		Air filter
	Engine, oil filter		Battery
	Hydraulic reservoir, level		Sprinkler
	Hydraulic fluid, filter		Sprinkler water
	Drum, oil level		Recycling
	Lubricating oil		Fuel filter



Maintenance - Maintenance schedule

Service and maintenance points

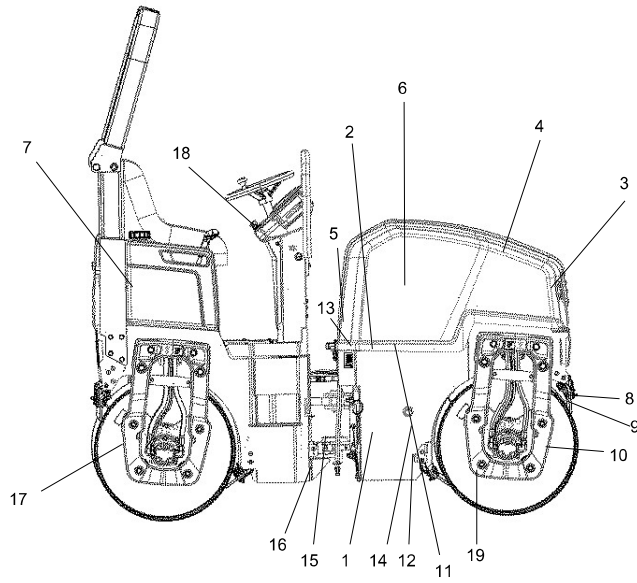




Fig. Service and maintenance points

- |                  |   |                                 |
|------------------|---|---------------------------------|
| 1. Fuel tank     | 8. Sprinkler system                       | 15. Steering joint              |
| 2. Refueling     | 9. Scrapers                               | 16. Steering cylinder, bearings |
| 3. Cooler        | 10. Shock absorbers and attachment screws | 17. Filler/Level plug, Drum     |
| 4. Air cleaner   | 11. Hydraulic fluid refilling             | 18. Emergency stop              |
| 5. Battery       | 12. Hydraulic fluid tank                  | 19. Edge cutter                 |
| 6. Diesel engine | 13. Hydraulic fluid filter                |                                 |
| 7. Water tank    | 14. Hydraulic fluid level glass           |                                 |

### General

Periodic maintenance should be carried out after the number of hours specified. Use the daily, weekly etc. periods where number of hours cannot be used.

 Remove all dirt before filling, when checking oils and fuel and when lubricating using oil or grease.

 The manufacturer's instructions found in the engine manual also apply.  
Specific maintenance and checks on diesel engines must be carried out by the engine supplier's certified personnel.

### Every 10 hours of operation (Daily)

Refer to the contents to find the page number of the sections referred to !

Pos. in fig	Action	Comment
	<b>Before starting up for the first time on that day</b>	
3	Clean the outside of the cooler package	In dusty conditions when necessary
3	Check coolant level	
6	Check the engine oil level	Refer to the engine manual
14	Check the hydraulic reservoir level	
3	Check for free circulation of cooling air	
2	Fill the fuel tank	
7	Fill the water tank	
8	Check the sprinkler system/Drum	
9	Check the scraper setting/Drum	
9	Check the spring loaded scrapers	Optional
	Test the brakes	

## Maintenance - Maintenance schedule

### After the FIRST 50 hours of operation

See Contents to find the page number of the sections referred to!

Pos. in fig	Action	Comment
6	Change the engine oil and oil filter	Refer to the engine manual
13	Change the hydraulic fluid filter	
10	Check bolted joints	

### Every 50 hours of operation (Weekly)

See Contents to find the page number of the sections referred to!

Pos. in fig	Action	Comment
4	Check indicator for air cleaner Check that the air hoses are in good condition and that the connections are tight	
15, 16	Grease the steering joint and the steering cylinder brackets	
	Check the fuel pipe and hose clamps	
	Drain the fuel prefilter/water separator	Only T4

### Every 250 / 750 / 1250 / 1750 hours of operation

See Contents to find the page number of the sections referred to!

Pos. in fig	Action	Comment
5	Check the battery condition	
6	Change the engine oil and oil filter	Refer to the engine manual
6	Cleaning the air filter	
6	Checking belts/belt tension	
3	Checking cooler hoses and hose clamps	
	Checking air intake hoses and hose clamps	

## Maintenance - Maintenance schedule

### Every 500 hours of operation

See Contents to find the page number of the sections referred to!

Pos. in fig	Action	Comment
5	Check the condition of the battery	
6	Change engine oil and oil filter	Refer to the engine manual
17	Check the oil level in the drum/drums	
10	Check rubber elements and bolted joints	
11	Check the hydraulic reservoir cover/breather	
15, 16	Lubricate the articulated joint and the steering cylinder's bearings	
3	Check coolant freezing point	Change the coolant every other year
4	Replace the air filter (main filter)	
6	Change the engine's fuel filter	Refer to the engine manual
6	Replacing the diesel engine's fuel prefilter/water separator	Refer to the engine manual
3	Checking cooler hoses and hose clamps	
	Checking air intake hoses and hose clamps	
1	Clean the fuel tank	
3	Clean the cooler package	
6	Replacing the diesel engine's V-belt	

## Maintenance - Maintenance schedule

### Every 1000 hours of operation

See Contents to find the page number of the sections referred to!

Pos. in fig	Action	Comment
5	Check the condition of the battery	
6	Change engine oil and oil filter	Refer to the engine manual
17	Check the oil level in the drum/drums	
10	Check the rubber elements and bolted joints	
11	Check the hydraulic reservoir cover/breather	
15, 16	Lubricate the articulated joint and the steering cylinder's bearings	
3	Check the freezing point of the coolant	Change every other year
4	Replace the air filters (main and backup filter)	or annually
6	Change the engine's fuel filter	Refer to the engine manual
6	Replace diesel engine's fuel prefilter / water separator	Refer to the engine manual
3	Check the cooler hoses and hose clamps	
1	Clean the fuel tank	
3	Clean the cooler package	
6	Check engine's valve clearances	Contact your local Kubota representative
	Checking air intake hoses and hose clamps	
	Change hydraulic fluid filter	
6	Replacing the diesel engine's V-belt	Refer to the engine manual

### Every 1500 hours of operation (only T4, T5 (28 kW))

Refer to the contents to find the page number of the sections referred to !

Pos. in fig	Action	Comment
	Checking the spreader	Contact your local Kubota representative
	Checking the EGR cooler	Contact your local Kubota representative
	Replacing the oil separator	
	Checking the fuel injection pressure	Contact your local Kubota representative

## Maintenance - Maintenance schedule

### Every 2000 hours of operation

See Contents to find the page numbers of the sections referred to!

Pos. in fig	Action	Comment
5	Check the battery condition	
6	Change the engine oil and oil filter	Refer to the engine manual
10	Check rubber elements and bolted joints	
11	Check the hydraulic reservoir cover/breather	
15, 16	Lubricate the articulated joint and the steering cylinder's bearings	
3	Check coolant freezing point	Change the coolant every other year
4	Replace the air filters (main and backup filter)	
13	Change hydraulic fluid filter	
6	Change the engine's fuel filter	Refer to the engine manual
6	Replacing the diesel engine's fuel prefilter/water separator	Refer to the engine manual
1	Drain and clean the fuel tank	
3	Clean the cooler package	
7	Drain and clean the water tank	
6	Check the engine valve clearances	Contact your local Kubota representative
12	Change the hydraulic fluid	
18, 17	Change/Check the oil in the drum/drums	
15	Check the condition of the articulation	
	Lubricate the edge cutter	
6	Replace the V-belt on the engine	



### Every 3000 hours of operation

See Contents to find the page numbers of the sections referred to!

Pos. in fig	Action	Comment
5	Check the battery condition	
6	Change the engine oil and oil filter	Refer to the engine manual
17	Check the oil level in the drum/drums	
10	Check rubber elements and bolted joints	
11	Check the hydraulic reservoir cover/breather	
15, 16	Lubricate the articulated joint and the steering cylinder's bearings	
3	Check coolant freezing point	Change the coolant every other year
4	Replace the air filters (main and backup filter)	
13	Change the hydraulic fluid filter	
6	Change the engine's fuel filter	Refer to the engine manual
6	Replace diesel engine's fuel prefilter / water separator	Refer to the engine manual
3	Checking cooler hoses and hose clamps	
1	Clean the fuel tank	
3	Clean the cooler package	
6	Check the engine valve clearances	Contact your local Kubota representative
7	Drain and clean the water tank	
12	Change the hydraulic fluid	
	Clean the air and fuel filters	
	Checking air intake hoses and hose clamps	
	Clean the Diesel particle filter ("DPF") (only D1803)	Contact your local Kubota representative
	Check the EGR system (only D1803)	Contact your local Kubota representative
	Check injection pump (only D1703)	Contact your local Kubota representative
15	Check the condition of the articulation	
6	Replace the V-belt on the engine	

## Maintenance - Maintenance schedule

---

### Every 12th month (Annually)

Refer to the contents to find the page number of the sections referred to !

Pos. in fig	Action	Comment
4	Replacing the air filters (main and backup filter)	
	Check the DPF pipes and connections (only D1803)	Contact your local Kubota representative
	Check the EGR pipes and connections (only D1803)	Contact your local Kubota representative
	Check the manifold (only D1803)	Contact your local Kubota representative

### Every 24th month (Every other year)

Refer to the contents to find the page number of the sections referred to !

Pos. in fig	Action	Comment
3	Replacing the coolant	
3	Checking cooler hoses and hose clamps	Replace when necessary
	Checking air intake hoses and hose clamps	Replace when necessary





**Maintenance, 10h**

Every 10 hours of operation (Daily)



***Park the roller on a level surface. The engine must be switched off and the parking brake activated when checking or adjusting the roller, unless otherwise specified.***



***Ensure that there is good ventilation (air extraction) if the engine is run indoors. Risk of carbon monoxide poisoning.***

**Check - Coolant system**

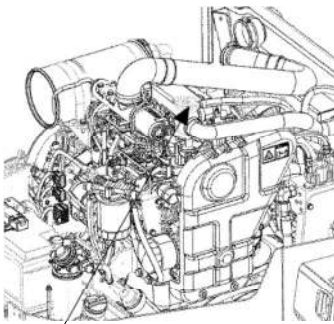
Check that all hoses/hose connectors are intact and tight. Fill with coolant as specified in the lubricants specification.



***Take great care when opening the radiator cap while the engine is hot. Wear protective gloves and goggles.***



Also check the freezing point. Change the coolant every other year.



1

**Figure. Cooling water container**  
**1. Filler cap**

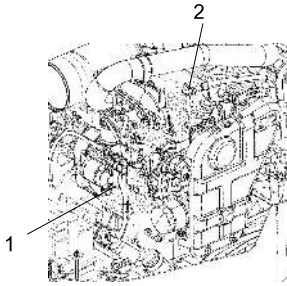


**Diesel engine Check oil level**

**!** *Ensure that the engine cover is fully open when work is carried out under the cover.*

Open the engine cover lock and lower the engine cover forwards.

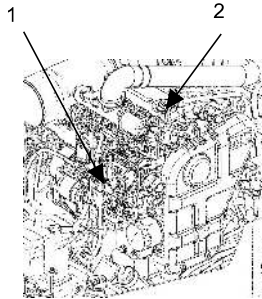
Check the oil level using the dipstick (1). The level should be between the marks. If the level is near the lower mark, top off with fresh engine oil via the filler cap (2). See under the heading lubricants for the correct oil grade.



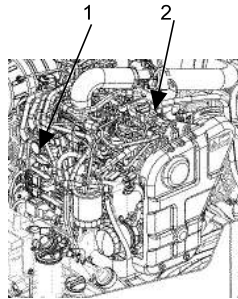
**Fig. Engine - D1703 (T3)**  
1. Dipstick  
2. Filler cap



**!** Never overfill with oil, as this can damage the engine.



**Fig. Diesel engine - D1703 (T4f, T5)**  
1. Dipstick  
2. Filler plug



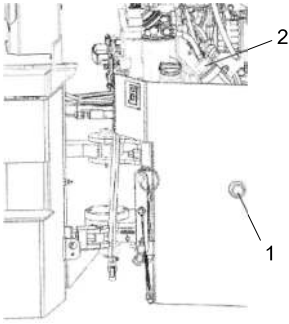
**Fig. Diesel engine - D1803 (T4f, T5)**  
1. Dipstick  
2. Filler plug

**Hydraulic reservoir, Level check - Filling**

Check that the oil level is visible in the sight glass.

Open the engine hood and unscrew the filler cap (2), top up with hydraulic fluid (as per lubricant specification) if the level is too low.

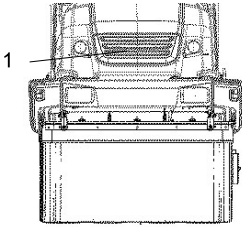
Screw on the cap again after filling.



**Fig. Hydraulic fluid tank**  
1. Sight glass  
2. Hydraulic fluid refilling

**Air circulation - Check**

Check that the engine has free circulation of cooling air through the grille (1) in the engine compartment.



**Fig. Front side**  
1. Cooling air grille

**Fuel tank - Filling**

Refuel the tank every day before starting work.

Open the engine hood, unscrew the tank cap (1) fill with diesel up to the lower edge of the filler pipe.

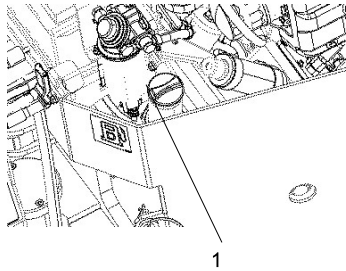


Fig. Fuel tank  
1. Filler cap



T4f/Stage IV and T5 / Stage V Kubota engines require the use of Ultra Low Sulphur Diesel (ULSD) fuel, which has a sulphur content of 15 ppm (parts per million) or less. Higher sulphur contents cause operating problems and put the useful life of components at risk, which can lead to engine trouble.



**Stop the diesel engine. Short-circuit (press) the filler gun against a non-insulated part of the roller before refuelling, and against the filler pipe while refuelling.**



**Never refuel while the engine is running. Do not smoke and avoid spilling fuel.**

The fuel tank holds 46 liters (47.6 qts).

**Water tank - Filling**

Unscrew the tank cap (1) and fill with clean water. Do not remove the strainer. See technical specifications for the tank volume.

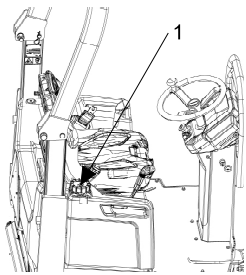


Fig. Water tank  
1. Tank cap



Only additive: A small amount of environment-friendly antifreeze.



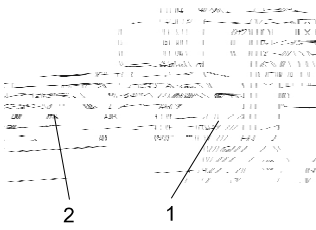


**Sprinkler system/Drum  
Checking - Cleaning**

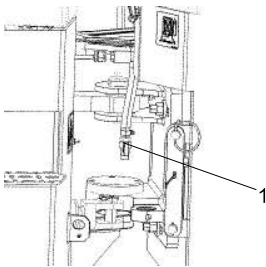
Start the sprinkler system and make sure that no nozzles (2) are clogged. If necessary, clean clogged nozzles and the coarse filter located by the water pump; see figures below.



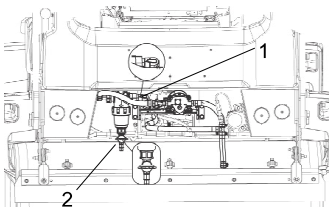
**Make sure that the watering system is empty/drained of water (sprinkler, hoses, tank/s) or that anti-freeze has been added, to prevent the system freezing. Close the ball valves (1) and draw up the anti-freeze liquid through the filter.**



**Fig. Drum**  
1. Ball valve  
2. Nozzle



**Fig. Articulated joint**  
1. Ball valve



**Fig. Sprinkler pump**  
1. Valve  
2. Filter

**Sprinkler - Drain / Anti-freeze**

Close the valve (1) and open all drains (filter, sprinkler pipes and center drain).

Run the pump for 15 seconds.

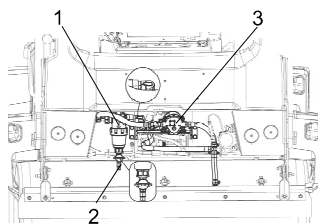
Close center and sprinkler drains

Fit a hose and a bottle with anti-freeze to the filter (2).

Run the sprinkler pump until you have anti-freeze coming through all nozzles.

Stop sprinkler pump and remove bottle.

Open all drains and drain the main water tank.

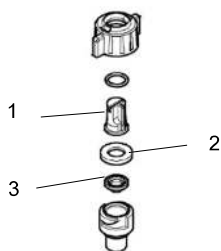


**Fig. Pump system**  
1. Water filter  
2. Drain cock  
3. Water pump

When cleaning the coarse filter (1), open the cock (2) and loosen the filter housing.

Clean the filter and filter housing. Check that the rubber gasket in the filter housing is intact.

After inspecting and carrying out any necessary cleaning, start the system and check that it works.



**Figure. Nozzle**  
1. Nozzle  
2. Gasket  
3. Filter

**Sprinkler system/Drum**  
**Cleaning of sprinkler nozzle**

Dismantle the blocked nozzle by hand.

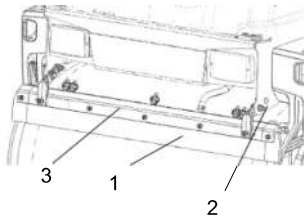
Blow the nozzle (1) and fine filter (3) clean using compressed air. Alternatively, fit replacement parts and clean the blocked parts later on.

Nozzle	Colour	l/min (at 2.0 bar)	gal/min (at 40 psi)
Standard	yellow	0.63	0.20
Option	blue	0.98	0.30
Option	red	1.31	0.40
Option	brown	1.63	0.50

After inspecting and carrying out any necessary cleaning, start the system and check that it works.



**Wear protective goggles when working with compressed air.**



**Fig. Drum**  
1. **Scraper blade**  
2. **Adjusting screws**  
3. **Mounting plate**

### Scrapers, fixed Checking - Setting

Make sure that the scrapers are undamaged. Adjust the scrapers so that they are 1-2 mm from the drum. For special asphalt compounds, it may be better if the scraper blades (1) lie lightly against the drums.

Asphalt remnants can accumulate on the scraper and affect the contact force. Clean as required.

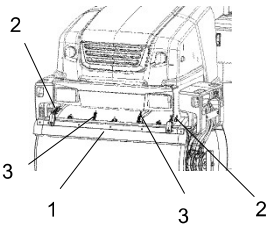
Loosen the screws (2) to adjust the contact pressure of the scraper blade against the drum.

Lock this setting by tightening the lock nut (2) against the mounting plate (3).

Adjust the contact surface on both scraper attachments.

Remember to tighten all the screws after any adjustment.

### Scrapers, spring-action (Optional) Checking - Adjustment



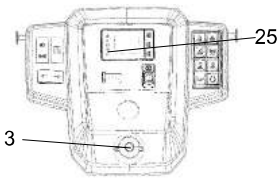
**Fig. Spring-action scrapers**  
1. **Scraper blade**  
2. **Adjusting screws**  
3. **Springs**



The scrapers must be lifted from the drum during transport.



**Brakes - Check**



**Figure. Instrument panel**  
3. Emergency stop  
25. Parking brake lamp



**Check operation of the brakes as follows:**

Run the roller very slowly forward. Hold the steering wheel firmly and brace yourself for a sudden stop.

Make sure the parking brake is deactivated and press in the emergency stop (3). The roller will stop abruptly and the engine is switched off.


After testing the brakes, set the forward/reverse lever in neutral.


Pull out the emergency stop (3), activate the parking brake and start the engine.

The roller is now ready for operation.

**Refer also to the section in the manual on operation.**

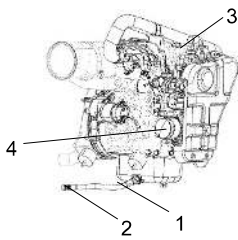
**Maintenance, first 50h**

 **Park the roller on a level surface. The engine must be switched off and the parking brake activated when checking or adjusting the roller, unless otherwise specified.**

 **Ensure that there is good ventilation (air extraction) if the engine is run indoors. Risk of carbon monoxide poisoning.**


**Engine oil and oil filter - Change**


Run the engine until it is warm before draining the oil .

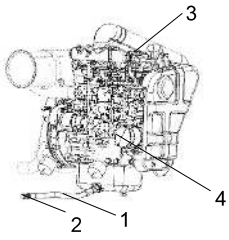


**Fig. Engine compartment right side - D1703-E3B (T3)**

1. Drain hose
2. Drain plug
3. Filler cap
4. Oil filter

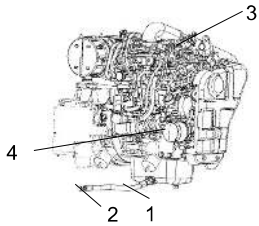
 **Switch off the engine and push in the emergency stop.**

 **Take great care when draining fluids and oils. Wear protective gloves and goggles.**



**Fig. Engine compartment, right side - D1703-E4B (T4f, T5)**

1. Drainage hose
2. Drain plug
3. Filler cap
4. Oil filter



**Fig. Engine compartment, right side - D1803-CR (T4f, T5)**

1. Drainage hose
2. Drain plug
3. Filler cap
4. Oil filter

Set a container which can hold at least 8 liters (2 gal) under the drain plug (2).

Undo the oil filler cap (3), and undo the drain plug (2) in the end of the drain hose (1). Let all the engine oil flow out.



Deliver the drained oil to special waste handling.



Refer to the engine manual for detailed instructions when changing oil and filters.

Remove the oil filter (4).

Collect any spillage.

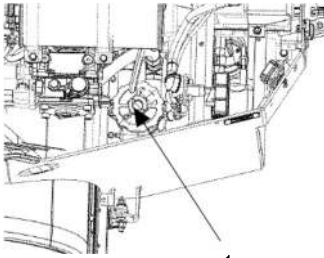
Install the new filter.

Fit the drain plug (2) to the end of the hose.

Fill with fresh engine oil. See under the heading lubricants, for the correct oil grade. Fit the filler cap (3) and check that the oil level is correct using the dipstick.

Start the engine and allow it to idle for a few minutes. During this time, check around the oil filter and drain plug for leaks.

Switch off the engine, wait for a minute or so and then check the oil level. Top up with more oil if necessary.

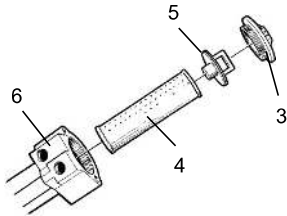
**Replacing the hydraulic oil filter**

**Fig. Engine compartment**  
**1. Filler cap**

Open the engine hood.

Loosen the red cap (1) and pull up the filter insert (4).

Refit the red cap temporarily to prevent dust and dirt getting into the tank.



**Fig. Hydraulic oil filter**  
**3. Cap**  
**4. Filter insert**  
**5. Handle**  
**6. Filter holder**

Release the filter insert (4) from the handle (5).



Remove the filter (4) and hand in to a waste disposal site. This is a disposable filter and cannot be cleaned.

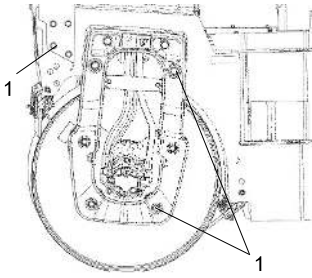
Mount the new insert on the handle, refit the unit into the filter holder (6), and refit the red cover.

Start the engine and allow it to run at full revs for 30 seconds. Check that the filter cap (3) is tight.

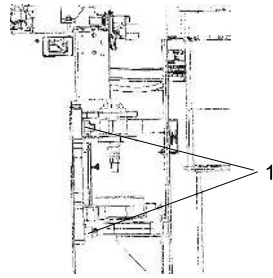
**Bolted joints**

**Check**

Check that all bolted joints (1) are tightened correctly.



*Fig. Drum forks*  
**1. Bolted joints**





*Fig. Articulated joint*  
**1. Bolted joints**



### Maintenance - 50h

Every 50 hours of operation (Weekly)

 **Park the roller on a level surface. The engine must be switched off and the parking brake activated when checking or adjusting the roller, unless otherwise specified.**

 **Ensure that there is good ventilation (air extraction) if the engine is run indoors. Risk of carbon monoxide poisoning.**

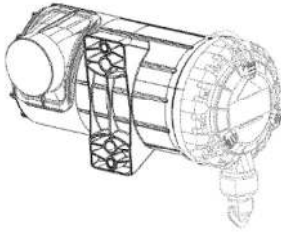



Fig. Air cleaner

#### Air cleaner

##### Check main filter

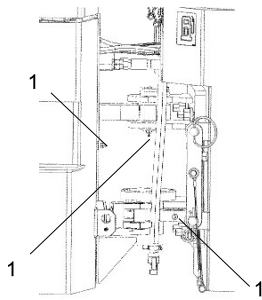
 Check the air cleaner's main filter when the indicator shows red. The indicator is mounted on the air cleaner's connecting pipe.



### Steering cylinder and steering joint - Lubrication



**Do not allow anyone to remain in the vicinity of the steering joint when the engine is running. Danger of crush injury when the steering is operated. Activate the parking brake before lubricating.**



**Fig. Articulated joint**  
**1. Lubricant nipples**

The machine must be in neutral (straight) when lubricated. All five grease nipples (1) can now be accessed.

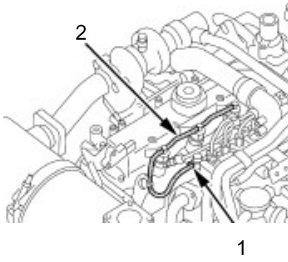
Wipe the grease nipples (1). Grease each nipple with five strokes of the hand-operated grease gun. Make sure that grease penetrates into the bearing. If grease does not penetrate the bearings, it may be necessary to relieve the articulation joint with a jack while repeating the greasing process.

**Checking the fuel hoses and hose clamps**

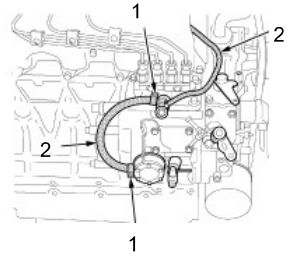
**Stop the engine before checking or replacing the fuel pipes. Defective fuel pipes can cause a fire.**



**If the fuel pipes are not connected, plug them at both ends with a clean cloth or paper to prevent dirt from entering. Dirt in the pipes can cause fuel injection pump failure.**



**Fig. Engine compartment (D1803)**  
1. Hose clamps  
2. Fuel pipes



**Fig. Engine compartment (D1703)**  
1. Hose clamps  
2. Fuel pipes

Check the fuel lines in case:

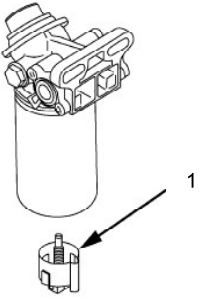
- Hose clamps are loose. Lubricate the screw in the clamp with oil and tighten the clamp properly.
- Fuel hoses are worn out. Replace them and the hose clamps every other year.

After replacing the pipes and strap, bleed the fuel system.

**Water separator - Draining  
(on machines equipped with this)**

If water or contaminants accumulate in the water separator, an indication will be shown on the display.

If this should happen during operation, drain from the draining plug. (1).



**Fig. Fuel prefilter**  
**1. Drain plug**

**Maintenance measures - 250 h**

Every 250/750/1250/1750..... hours of operation (every 3 months)



**Park the roller on a level surface. The engine must be switched off and the parking brake activated when checking or adjusting the roller, unless otherwise specified.**



**Ensure that there is good ventilation (air extraction) if the engine is run indoors. Risk of carbon monoxide poisoning.**

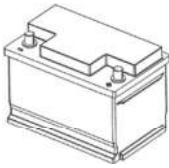


Fig. Battery

**Battery  
- Check condition**

The battery is sealed and maintenance-free.



**Make sure there is no open flame in the vicinity when checking the electrolyte level. Explosive gas is formed when the alternator charges the battery.**



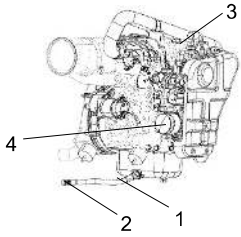
**When disconnecting the battery, always disconnect the negative cable first. When connecting the battery, always connect the positive cable first.**

The cable shoes should be clean and well-tightened. Corroded cable shoes should be cleaned and greased with acid-free Vaseline.

Wipe the top of the battery.

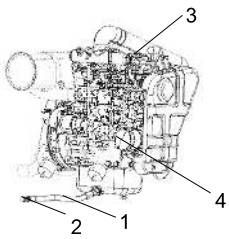
**Engine oil and oil filter - Change**

Run the engine until it is warm before draining the oil .



**Fig. Engine compartment right side - D1703-E3B (T3)**

1. Drain hose
2. Drain plug
3. Filler cap
4. Oil filter



**Fig. Engine compartment, right side - D1703-E4B (T4f, T5)**

1. Drainage hose
2. Drain plug
3. Filler cap
4. Oil filter



**Switch off the engine and push in the emergency stop.**



**Take great care when draining fluids and oils. Wear protective gloves and goggles.**

Set a container which can hold at least 8 liters (2 gal) under the drain plug (2).

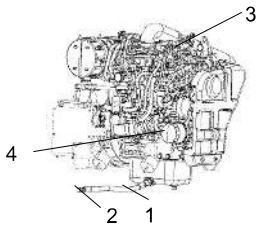
Undo the oil filler cap (3), and undo the drain plug (2) in the end of the drain hose (1). Let all the engine oil flow out.



**Deliver the drained oil to special waste handling.**



**Refer to the engine manual for detailed instructions when changing oil and filters.**



**Fig. Engine compartment, right side - D1803-CR (T4f, T5)**  
 1. Drainage hose  
 2. Drain plug  
 3. Filler cap  
 4. Oil filter

Remove the oil filter (4).

Collect any spillage.

Install the new filter.

Fit the drain plug (2) to the end of the hose.

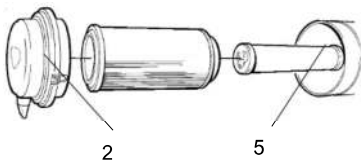
Fill with fresh engine oil. See under the heading lubricants, for the correct oil grade. Fit the filler cap (3) and check that the oil level is correct using the dipstick.

Start the engine and allow it to idle for a few minutes. During this time, check around the oil filter and drain plug for leaks.

Switch off the engine, wait for a minute or so and then check the oil level. Top up with more oil if necessary.



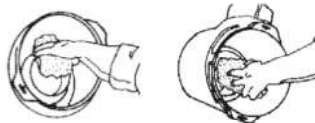
**Air cleaner  
- Cleaning**



Wipe the inside of the cover (2) and filter housing (5).

**Fig. Air cleaner**  
 2. Cover  
 5. Filter housing

Wipe clean on both sides of the outlet pipe.



Inner edge of outlet pipe.



Outer edge of outlet pipe.

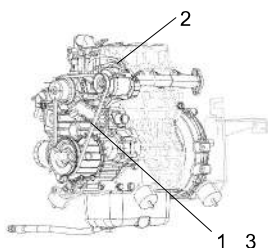
Wipe also both surfaces for the outlet pipe; see adjacent figure.



Check that the hose clamps between the filter housing and the suction hose are tight and that the hoses are intact. Inspect the entire hose system, all the way to the engine.

**Replacing belts/Checking the belt tension**

-  **Exercise care to stop the engine and remove the key before checking the belt tension.**
-  **Exercise care to install the standalone safety shield after maintenance or inspection.**



**Fig. Diesel engine - D1703 (T4f, T5)**  
1. Belt  
2. Bolt and nut  
3. Deflection between 7 to 9 mm  
(0.28 to 0.35 in.)


Stop the engine and remove the key.

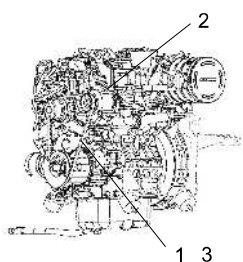
If necessary, remove the belt guard.

Apply a moderate pressure with your thumb on the belt, between the belt pulleys on the alternator and crankshaft, to check the belt tension. The deflection should be between 7 and 9 mm (0.28 to 0.35 in.).

If the belt tension is not sufficient: - Loosen the fastening bolts that hold the alternator in place. - Use a prybar/lever and place it between the alternator and engine block, push the alternator outwards to achieve the required belt tension.

Tighten the bolts holding the alternator with the correct torque.

-  **If the belt is loose or damaged, it may result in insufficient charging. Adjust or replace the belt.**



**Fig. Diesel engine - D1803 (T4f, T5)**  
1. Belt  
2. Bolt and nut  
3. Deflection between 7 to 9 mm  
(0.28 to 0.35 in.)





### Check - Coolant system

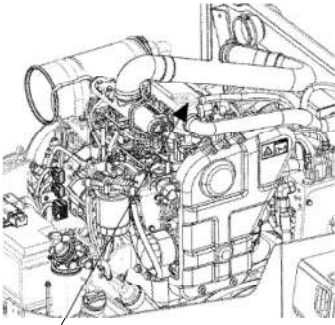
Check that all hoses/hose connectors are intact and tight. Fill with coolant as specified in the lubricants specification.



**Take great care when opening the radiator cap while the engine is hot. Wear protective gloves and goggles.**



Also check the freezing point. Change the coolant every other year.

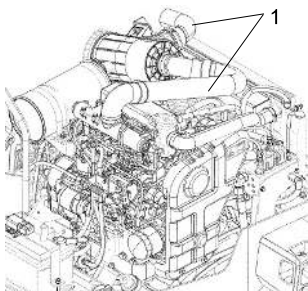


1

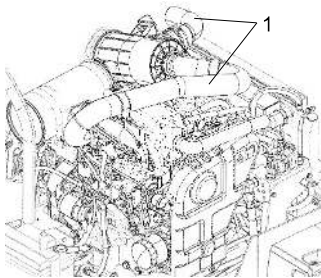
Figure. Cooling water container  
1. Filler cap

**Check - Air intake hoses**

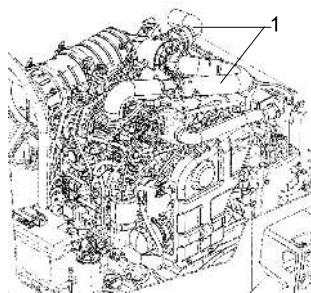
Check that all hoses/hose connections are intact and tight.



**Fig. Engine compartment -  
D1703-M-DI-E4B (T4f, T5)**  
1. Air intake hoses





**Fig. Engine compartment -  
D1703-M-DI-E3 (T3)**  
1. Air intake hoses



**Fig. Engine compartment - D1803 CR  
(T4f, T5)**  
1. Air intake hoses

## Maintenance - 500h

 **Park the roller on a level surface. The engine must be switched off and the parking brake activated when checking or adjusting the roller, unless otherwise specified.**

 **Ensure that there is good ventilation (air extraction) if the engine is run indoors. Risk of carbon monoxide poisoning.**

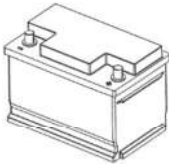




Fig. Battery

**Battery**  
**- Check condition**

The battery is sealed and maintenance-free.

 **Make sure there is no open flame in the vicinity when checking the electrolyte level. Explosive gas is formed when the alternator charges the battery.**

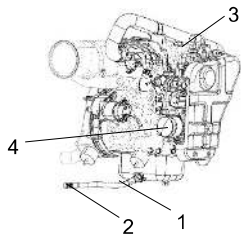
 When disconnecting the battery, always disconnect the negative cable first. When connecting the battery, always connect the positive cable first.

The cable shoes should be clean and well-tightened. Corroded cable shoes should be cleaned and greased with acid-free Vaseline.

Wipe the top of the battery.

**Engine oil and oil filter - Change**

Run the engine until it is warm before draining the oil .



**Fig. Engine compartment right side -  
D1703-E3B (T3)**

1. Drain hose
2. Drain plug
3. Filler cap
4. Oil filter



**Switch off the engine and push in the emergency stop.**



**Take great care when draining fluids and oils.  
Wear protective gloves and goggles.**

Set a container which can hold at least 8 liters (2 gal)  
under the drain plug (2).

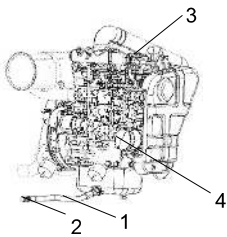
Undo the oil filler cap (3), and undo the drain plug (2)  
in the end of the drain hose (1). Let all the engine oil  
flow out.



**Deliver the drained oil to special waste handling.**

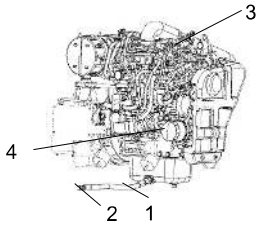


**Refer to the engine manual for detailed  
instructions when changing oil and filters.**



**Fig. Engine compartment, right side -  
D1703-E4B (T4f, T5)**

1. Drainage hose
2. Drain plug
3. Filler cap
4. Oil filter



**Fig. Engine compartment, right side - D1803-CR (T4f, T5)**  
1. Drainage hose  
2. Drain plug  
3. Filler cap  
4. Oil filter

Remove the oil filter (4).

Collect any spillage.

Install the new filter.

Fit the drain plug (2) to the end of the hose.

Fill with fresh engine oil. See under the heading lubricants, for the correct oil grade. Fit the filler cap (3) and check that the oil level is correct using the dipstick.

Start the engine and allow it to idle for a few minutes. During this time, check around the oil filter and drain plug for leaks.

Switch off the engine, wait for a minute or so and then check the oil level. Top up with more oil if necessary.

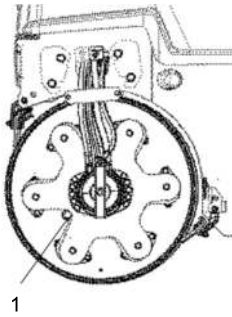


### **Drum - oil level Inspection - filling**

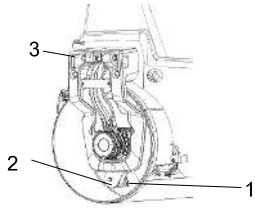
Run the roller slowly until the oil plug (1) is positioned as illustrated.

Unscrew the plug and check that the oil level reaches up to the bottom of the hole. Top up with new oil if necessary. Use oil as per the lubricant specification.

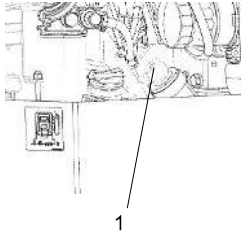
Clean the magnetic oil plug (1) from any metallic residue, and refit the plug.



**Fig. Drum vibration side**  
1. Oil plug



**Fig. Drum end**  
1. Rubber element  
2. Fastening screws  
3. Bolted joints



**Fig. Engine compartment**  
1. Tank cap, hydraulic fluid

### Rubber elements and bolted joints

#### Check

Check all rubber elements (1). Replace all elements where more than 25% of the elements on one side of the drum have cracks deeper than 10-15 mm (0.4-0.6 in).

Check using a knife blade or pointed object.

Check also that the attachment screws (2) are tightened.

### Hydraulic reservoir cap - Check

Screw off the tank cap and check that it is not clogged. Air must have unobstructed passage through the cap in both directions.

If clogged in either direction, clean with a little diesel oil and blow with compressed air until free passage is assured or replace the cap with a new one.



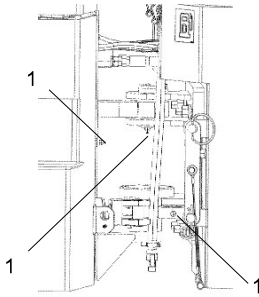
**Wear protective goggles when working with compressed air.**



### Steering cylinder and steering joint - Lubrication



**Do not allow anyone to remain in the vicinity of the steering joint when the engine is running. Danger of crush injury when the steering is operated. Activate the parking brake before lubricating.**



**Fig. Articulated joint**  
**1. Lubricant nipples**

The machine must be in neutral (straight) when lubricated. All five grease nipples (1) can now be accessed.

Wipe the grease nipples (1). Grease each nipple with five strokes of the hand-operated grease gun. Make sure that grease penetrates into the bearing. If grease does not penetrate the bearings, it may be necessary to relieve the articulation joint with a jack while repeating the greasing process.

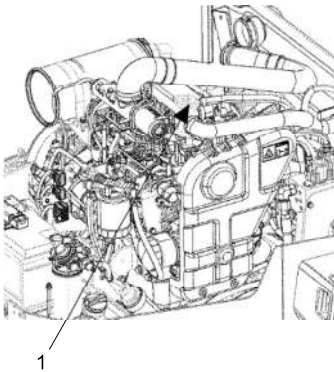


### Check - Coolant system

Check that all hoses/hose connectors are intact and tight. Fill with coolant as specified in the lubricants specification.



**Take great care when opening the radiator cap while the engine is hot. Wear protective gloves and goggles.**



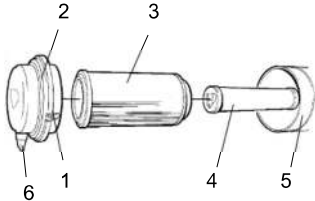
**Figure. Cooling water container**  
**1. Filler cap**



Also check the freezing point. Change the coolant every other year.

**Air cleaner****Check - Replacement of main filter**

Replace the air cleaner's main filter when the indicator shows red. The indicator is located on the filter, or in its immediate vicinity.



**Fig. Air cleaner**  
1. Clips  
2. Cover  
3. Main filter  
4. Backup filter  
5. Filter housing  
6. Dust valve

Release the clips (1), pull off the cover (2), and pull out the main filter (3).

Do not remove the backup filter (4).

Clean the air cleaner if necessary, see section Air cleaner - Cleaning.

When replacing the main filter (3), insert a new filter and refit the air cleaner in the reverse order.

Check the condition of the dust valve (6); replace if necessary.

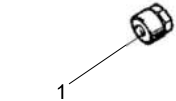
When refitting the cover, make sure that the dust valve is positioned downwards.

**Air filter indicator - Resetting**

The air filter indicator is located on the filter, or in its immediate vicinity.

The air filter indicator must be reset after replacing the air filter.

Press the "button" (1) on the top of the indicator to reset.



**Fig. Indicator**  
1. Button





### Replacing the fuel filter

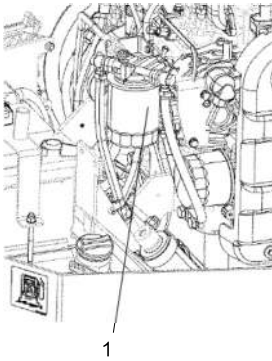


Fig. Engine compartment, right side  
1. Fuel filter



Place a container underneath to collect fuel that runs out when the filter is released.

Screw off the fuel filter (1). The filter is of the disposable type and cannot be cleaned. Hand in to a waste disposal site.

Install the new filter.

Start the engine and check that the fuel filter is tight.



Refer to the engine manual for detailed instructions when replacing the fuel filter.



**Ensure good ventilation (air extraction) if the diesel engine is run indoors. Risk of carbon monoxide poisoning.**



### Replacing the pre-filter

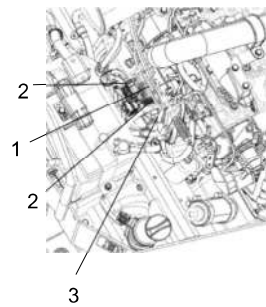
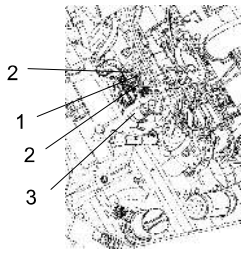


Fig. Engine compartment -  
D1703-M-IDI-E3 (T3)  
1. Pre-filter  
2. Hose clamps  
3. Fuel pump

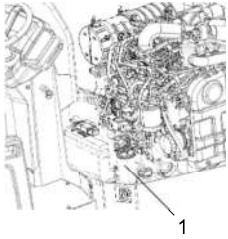


Place a container underneath to collect fuel that runs out when the filter is released.

Activate the parking brake.  
Switch off the engine and open the engine hood.



**Fig. Engine compartment -  
D1703-M-DI-E4B (T4f, T5)**  
1. Pre-filter  
2. Hose clamps  
3. Fuel pump



**Fig. Engine compartment - D1803 CR  
(T4f, T5)**  
1. Pre-filter

**D1703**

The prefilter is located to the left of the fuel pump in the engine compartment.

Loosen the hose clamps (2) using a screwdriver.

Remove the pre-filter (1) and hand in to a waste disposal site. This is a disposable filter and cannot be cleaned.

Fit a new pre-filter and tighten the hose clamps.

Start the engine and check that the pre-filter is tight.

**D1803**

Unscrew the fuel filter (1) located on the right side of the battery in the engine compartment.

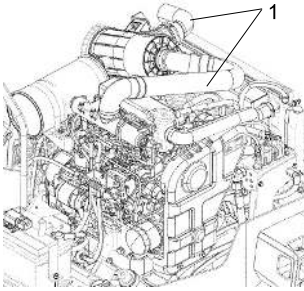
Install a new fuel filter



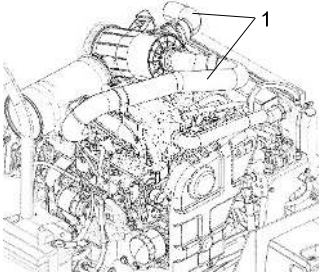
**Ensure good ventilation (air extraction) if the diesel engine is run indoors. Risk of carbon monoxide poisoning.**

**Check - Air intake hoses**

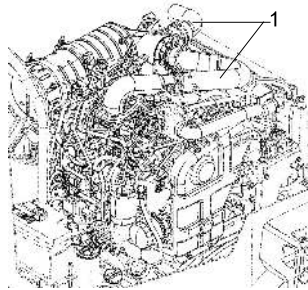
Check that all hoses/hose connections are intact and tight.



*Fig. Engine compartment -  
D1703-M-DI-E4B (T4f, T5)*  
1. Air intake hoses



*Fig. Engine compartment -  
D1703-M-DI-E3 (T3)*  
1. Air intake hoses



*Fig. Engine compartment - D1803 CR  
(T4f, T5)*  
1. Air intake hoses



### Fuel tank - Cleaning

It is easiest to clean the tank when it is almost empty.



Pump out any bottom sediment using a suitable pump, such as an oil drain pump. Save the oil in a container and dispose of it in an approved manner.



**Keep in mind fire risk when handling fuel.**



The fuel tank is made of plastic (polyethylene) and is recyclable.

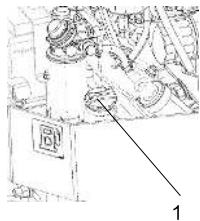


Fig. Fuel tank  
1. Fuel tank

### Fuel filter's water separator - Draining (on machines equipped with this)

If water or contaminants accumulate in the fuel filter's water separator, an indication will be shown on the display.

If this should happen during operation, drain from the draining plug. (1).

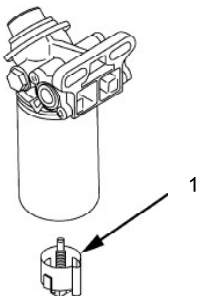
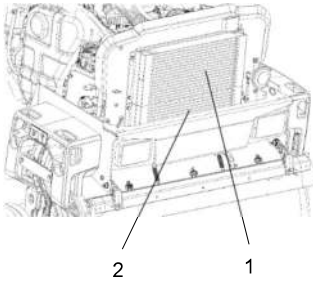


Fig. Fuel prefilter  
1. Drain plug



**Fig. Engine compartment**  
**1. Water cooler**  
**2. Hydraulic fluid cooler**

### **Coolers**

#### **Checking - Cleaning**

Make sure that the air flow through the coolers (1) and (2) is unobstructed. Dirty coolers are blown clean with compressed air or washed clean using a high-pressure water cleaner.

Blow air or direct water through the cooler in the opposite direction to that of the cooling air.





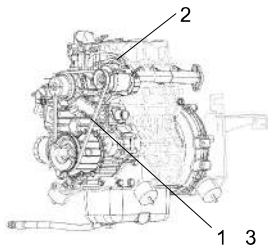
Take care when using a high-pressure water jet. Do not hold the nozzle too near the cooler.



***Wear protective goggles when working with compressed air or high-pressure water jets.***

**Replacing belts/Checking the belt tension**

-  **Exercise care to stop the engine and remove the key before checking the belt tension.**
-  **Exercise care to install the standalone safety shield after maintenance or inspection.**



**Fig. Diesel engine - D1703 (T4f, T5)**  
1. Belt  
2. Bolt and nut  
3. Deflection between 7 to 9 mm  
(0.28 to 0.35 in.)


Stop the engine and remove the key.

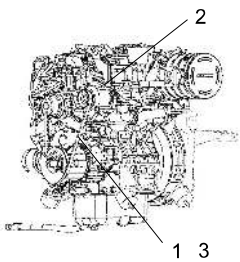
If necessary, remove the belt guard.

Apply a moderate pressure with your thumb on the belt, between the belt pulleys on the alternator and crankshaft, to check the belt tension. The deflection should be between 7 and 9 mm (0.28 to 0.35 in.).

If the belt tension is not sufficient: - Loosen the fastening bolts that hold the alternator in place. - Use a prybar/lever and place it between the alternator and engine block, push the alternator outwards to achieve the required belt tension.

Tighten the bolts holding the alternator with the correct torque.

-  **If the belt is loose or damaged, it may result in insufficient charging. Adjust or replace the belt.**



**Fig. Diesel engine - D1803 (T4f, T5)**  
1. Belt  
2. Bolt and nut  
3. Deflection between 7 to 9 mm  
(0.28 to 0.35 in.)

**Maintenance - 1000h**

Performed after 1000 operating hours (each year)



***Park the roller on a level surface.  
The engine must be switched off and the  
parking brake activated when checking or  
adjusting the roller, unless otherwise specified.***



***Ensure that there is good ventilation (air  
extraction) if the engine is run indoors. Risk of  
carbon monoxide poisoning.***

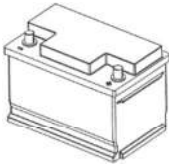


Fig. Battery

**Battery****- Check condition**

The battery is sealed and maintenance-free.



***Make sure there is no open flame in the vicinity  
when checking the electrolyte level. Explosive gas  
is formed when the alternator charges the battery.***



When disconnecting the battery, always disconnect the negative cable first. When connecting the battery, always connect the positive cable first.

The cable shoes should be clean and well-tightened. Corroded cable shoes should be cleaned and greased with acid-free Vaseline.

Wipe the top of the battery.



### Engine oil and oil filter - Change

Run the engine until it is warm before draining the oil .

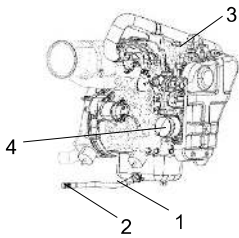


Fig. Engine compartment right side - D1703-E3B (T3)

- 1. Drain hose
- 2. Drain plug
- 3. Filler cap
- 4. Oil filter



**Switch off the engine and push in the emergency stop.**



**Take great care when draining fluids and oils. Wear protective gloves and goggles.**

Set a container which can hold at least 8 liters (2 gal) under the drain plug (2).

Undo the oil filler cap (3), and undo the drain plug (2) in the end of the drain hose (1). Let all the engine oil flow out.



Deliver the drained oil to special waste handling.



Refer to the engine manual for detailed instructions when changing oil and filters.

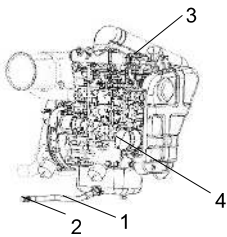
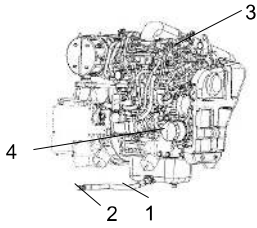


Fig. Engine compartment, right side - D1703-E4B (T4f, T5)

- 1. Drainage hose
- 2. Drain plug
- 3. Filler cap
- 4. Oil filter





**Fig. Engine compartment, right side - D1803-CR (T4f, T5)**  
1. Drainage hose  
2. Drain plug  
3. Filler cap  
4. Oil filter

Remove the oil filter (4).

Collect any spillage.

Install the new filter.

Fit the drain plug (2) to the end of the hose.

Fill with fresh engine oil. See under the heading lubricants, for the correct oil grade. Fit the filler cap (3) and check that the oil level is correct using the dipstick.

Start the engine and allow it to idle for a few minutes. During this time, check around the oil filter and drain plug for leaks.

Switch off the engine, wait for a minute or so and then check the oil level. Top up with more oil if necessary.

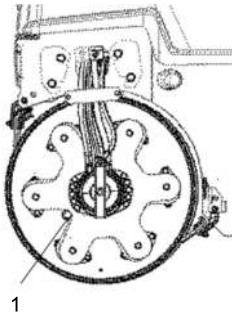


### **Drum - oil level Inspection - filling**

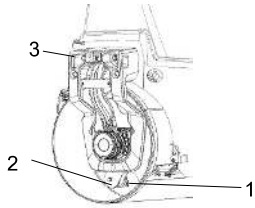
Run the roller slowly until the oil plug (1) is positioned as illustrated.

Unscrew the plug and check that the oil level reaches up to the bottom of the hole. Top up with new oil if necessary. Use oil as per the lubricant specification.

Clean the magnetic oil plug (1) from any metallic residue, and refit the plug.



**Fig. Drum vibration side**  
1. Oil plug



**Fig. Drum end**  
1. Rubber element  
2. Fastening screws  
3. Bolted joints

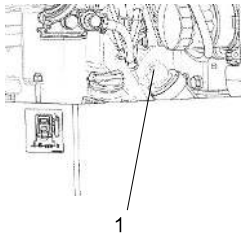
### Rubber elements and bolted joints

#### Check

Check all rubber elements (1). Replace all elements where more than 25% of the elements on one side of the drum have cracks deeper than 10-15 mm (0.4-0.6 in).

Check using a knife blade or pointed object.

Check also that the attachment screws (2) are tightened.



**Fig. Engine compartment**  
1. Tank cap, hydraulic fluid

### Hydraulic reservoir cap - Check

Screw off the tank cap and check that it is not clogged. Air must have unobstructed passage through the cap in both directions.

If clogged in either direction, clean with a little diesel oil and blow with compressed air until free passage is assured or replace the cap with a new one.



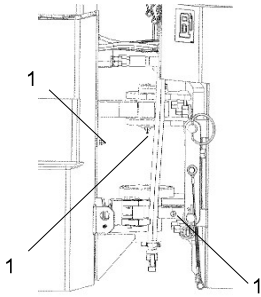
**Wear protective goggles when working with compressed air.**



### Steering cylinder and steering joint - Lubrication



**Do not allow anyone to remain in the vicinity of the steering joint when the engine is running. Danger of crush injury when the steering is operated. Activate the parking brake before lubricating.**



**Fig. Articulated joint**  
**1. Lubricant nipples**

The machine must be in neutral (straight) when lubricated. All five grease nipples (1) can now be accessed.

Wipe the grease nipples (1). Grease each nipple with five strokes of the hand-operated grease gun. Make sure that grease penetrates into the bearing. If grease does not penetrate the bearings, it may be necessary to relieve the articulation joint with a jack while repeating the greasing process.

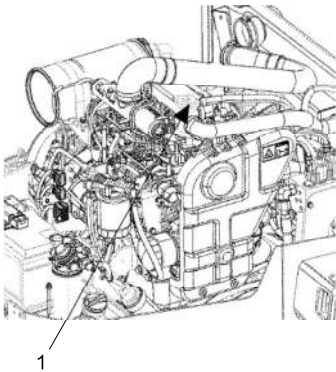


### Check - Coolant system

Check that all hoses/hose connectors are intact and tight. Fill with coolant as specified in the lubricants specification.



**Take great care when opening the radiator cap while the engine is hot. Wear protective gloves and goggles.**



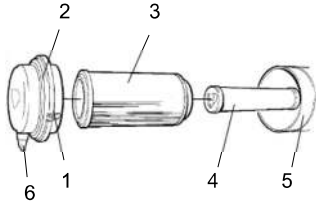
**Figure. Cooling water container**  
**1. Filler cap**



Also check the freezing point. Change the coolant every other year.

**Air cleaner****Check - Replacement of main filter**

Replace the air cleaner's main filter when the indicator shows red. The indicator is mounted on the air cleaner's connecting pipe.



**Fig. Air cleaner**  
1. Clips  
2. Cover  
3. Main filter  
4. Backup filter  
5. Filter housing  
6. Dust valve

Release the clips (1), pull off the cover (2), and pull out the main filter (3).

Do not remove the backup filter (4).

Clean the air cleaner if necessary, see section Air cleaner - Cleaning.

When replacing the main filter (3), insert a new filter and refit the air cleaner in the reverse order.

Check the condition of the dust valve (6); replace if necessary.

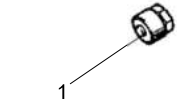
When refitting the cover, make sure that the dust valve is positioned downwards.

**Air filter indicator - Resetting**

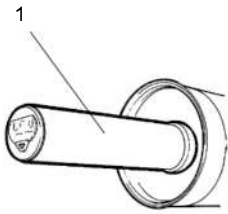
The air filter indicator is located on the filter, or in its immediate vicinity.

The air filter indicator must be reset after replacing the air filter.

Press the "button" (1) on the top of the indicator to reset.



**Fig. Indicator**  
1. Button

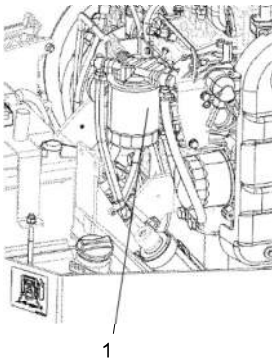
**Backup filter - Change**

**Fig. Air filter**  
**1. Backup filter**

Change the backup filter with a new filter after every third replacement of the main filter.

To change the backup filter (1), pull the old filter out of its holder, insert a new filter and reassemble the air cleaner in the reverse order.

Clean the air cleaner if necessary, see section Air cleaner - Cleaning.

**Replacing the fuel filter**

**Fig. Engine compartment, right side**  
**1. Fuel filter**



Place a container underneath to collect fuel that runs out when the filter is released.

Screw off the fuel filter (1). The filter is of the disposable type and cannot be cleaned. Hand in to a waste disposal site.

Install the new filter.

Start the engine and check that the fuel filter is tight.



Refer to the engine manual for detailed instructions when replacing the fuel filter.



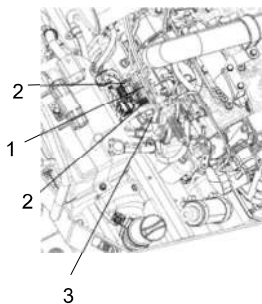
**Ensure good ventilation (air extraction) if the diesel engine is run indoors. Risk of carbon monoxide poisoning.**


**Replacing the pre-filter**

Activate the parking brake.  
 Switch off the engine and open the engine hood.

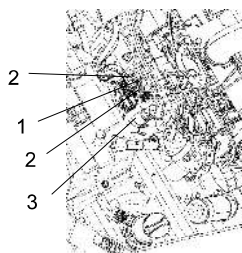


Place a container underneath to collect fuel that runs out when the filter is released.



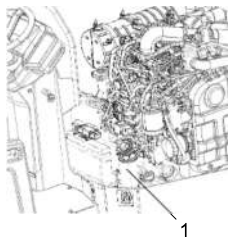
**Fig. Engine compartment - D1703-M-DI-E3 (T3)**

1. Pre-filter
2. Hose clamps
3. Fuel pump



**Fig. Engine compartment - D1703-M-DI-E4B (T4f, T5)**

1. Pre-filter
2. Hose clamps
3. Fuel pump



**Fig. Engine compartment - D1803 CR (T4f, T5)**

1. Pre-filter

**D1703**

The prefilter is located to the left of the fuel pump in the engine compartment.

Loosen the hose clamps (2) using a screwdriver.

Remove the pre-filter (1) and hand in to a waste disposal site. This is a disposable filter and cannot be cleaned.

Fit a new pre-filter and tighten the hose clamps.

Start the engine and check that the pre-filter is tight.

**D1803**

Unscrew the fuel filter (1) located on the right side of the battery in the engine compartment.


Install a new fuel filter




**Ensure good ventilation (air extraction) if the diesel engine is run indoors. Risk of carbon monoxide poisoning.**

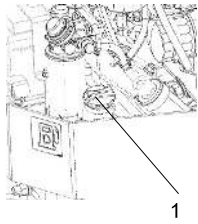
**Fuel tank - Cleaning**

It is easiest to clean the tank when it is almost empty.

 Pump out any bottom sediment using a suitable pump, such as an oil drain pump. Save the oil in a container and dispose of it in an approved manner.

 **Keep in mind fire risk when handling fuel.**

 The fuel tank is made of plastic (polyethylene) and is recyclable.





**Fig. Fuel tank**  
1. Fuel tank

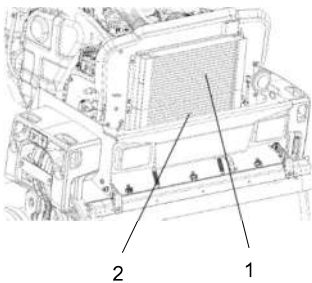
**Coolers  
Checking - Cleaning**

Make sure that the air flow through the coolers (1) and (2) is unobstructed. Dirty coolers are blown clean with compressed air or washed clean using a high-pressure water cleaner.

Blow air or direct water through the cooler in the opposite direction to that of the cooling air.

 Take care when using a high-pressure water jet. Do not hold the nozzle too near the cooler.

 **Wear protective goggles when working with compressed air or high-pressure water jets.**



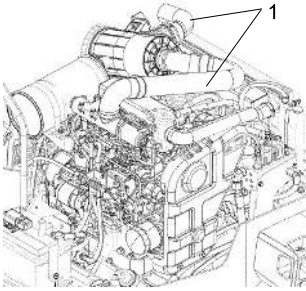
**Fig. Engine compartment**  
1. Water cooler  
2. Hydraulic fluid cooler

**Checking of EGR cooler**

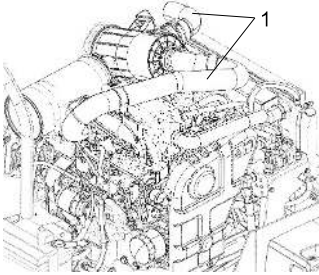
Contact your local Kubota representative for this service

**Check - Air intake hoses**

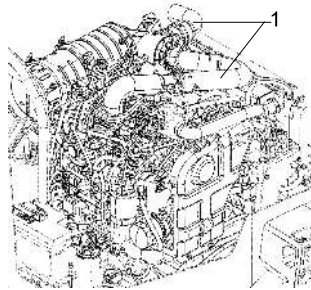
Check that all hoses/hose connections are intact and tight.



**Fig. Engine compartment -  
D1703-M-DI-E4B (T4f, T5)**  
1. Air intake hoses



**Fig. Engine compartment -  
D1703-M-DI-E3 (T3)**  
1. Air intake hoses



**Fig. Engine compartment - D1803 CR  
(T4f, T5)**  
1. Air intake hoses



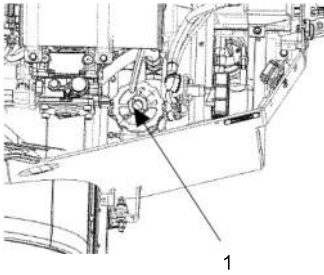


### Replacing the hydraulic oil filter

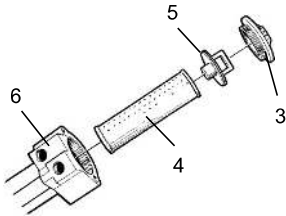
Open the engine hood.

Loosen the red cap (1) and pull up the filter insert (4).

Refit the red cap temporarily to prevent dust and dirt getting into the tank.



**Fig. Engine compartment**  
1. Filler cap



**Fig. Hydraulic oil filter**  
3. Cap  
4. Filter insert  
5. Handle  
6. Filter holder

Release the filter insert (4) from the handle (5).





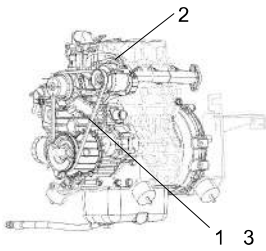
Remove the filter (4) and hand in to a waste disposal site. This is a disposable filter and cannot be cleaned.

Mount the new insert on the handle, refit the unit into the filter holder (6), and refit the red cover.

Start the engine and allow it to run at full revs for 30 seconds. Check that the filter cap (3) is tight.

**Replacing belts/Checking the belt tension**

-  **Exercise care to stop the engine and remove the key before checking the belt tension.**
-  **Exercise care to install the standalone safety shield after maintenance or inspection.**



**Fig. Diesel engine - D1703 (T4f, T5)**  
1. Belt  
2. Bolt and nut  
3. Deflection between 7 to 9 mm  
(0.28 to 0.35 in.)


Stop the engine and remove the key.

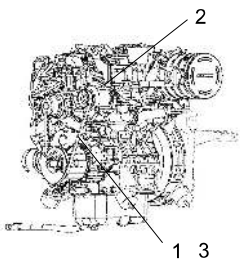
If necessary, remove the belt guard.

Apply a moderate pressure with your thumb on the belt, between the belt pulleys on the alternator and crankshaft, to check the belt tension. The deflection should be between 7 and 9 mm (0.28 to 0.35 in.).

If the belt tension is not sufficient: - Loosen the fastening bolts that hold the alternator in place. - Use a prybar/lever and place it between the alternator and engine block, push the alternator outwards to achieve the required belt tension.

Tighten the bolts holding the alternator with the correct torque.

-  **If the belt is loose or damaged, it may result in insufficient charging. Adjust or replace the belt.**



**Fig. Diesel engine - D1803 (T4f, T5)**  
1. Belt  
2. Bolt and nut  
3. Deflection between 7 to 9 mm  
(0.28 to 0.35 in.)

**Maintenance measures - 1500 h (only T4f, T5 (28 kW))**

**Check - Spreader**

Contact your local Kubota representative for this service

**Check - EGR cooler**

Contact your local Kubota representative for this service

**Replacing the oil separator**

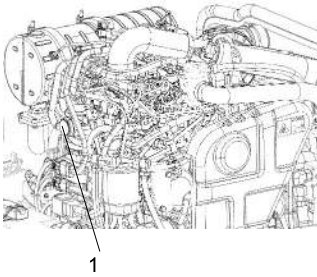


**Stop the engine before replacing the oil separator.**

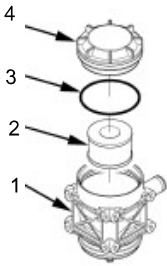
Remove the cover (4) and take out the oil separator element (2) and gasket (3).

Clean up oil and grease.

Install a new oil separator and gasket.



**Fig. Engine room**  
1. Oil separator



**Fig. Oil separator**  
1. Cup  
2. Separator  
3. Seal  
4. Cover

**Checking of injector tip**

Contact your local Kubota representative for this service

### Maintenance - 2000h

Performed after 2000 operating hours (every two years)



**Park the roller on a level surface. The engine must be switched off and the parking brake activated when checking or adjusting the roller, unless otherwise specified.**



**Ensure that there is good ventilation (air extraction) if the engine is run indoors. Risk of carbon monoxide poisoning.**

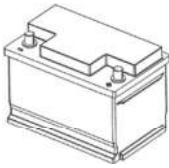


Fig. Battery

#### Battery - Check condition

The battery is sealed and maintenance-free.



**Make sure there is no open flame in the vicinity when checking the electrolyte level. Explosive gas is formed when the alternator charges the battery.**



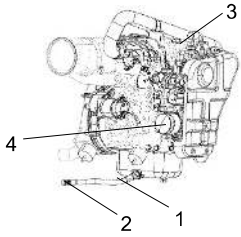
When disconnecting the battery, always disconnect the negative cable first. When connecting the battery, always connect the positive cable first.

The cable shoes should be clean and well-tightened. Corroded cable shoes should be cleaned and greased with acid-free Vaseline.

Wipe the top of the battery.

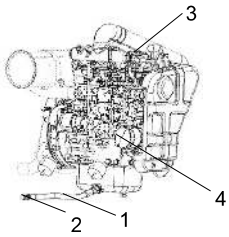
**Engine oil and oil filter - Change**

Run the engine until it is warm before draining the oil .



**Fig. Engine compartment right side -  
D1703-E3B (T3)**

1. Drain hose
2. Drain plug
3. Filler cap
4. Oil filter



**Fig. Engine compartment, right side -  
D1703-E4B (T4f, T5)**

1. Drainage hose
2. Drain plug
3. Filler cap
4. Oil filter



**Switch off the engine and push in the emergency stop.**



**Take great care when draining fluids and oils.  
Wear protective gloves and goggles.**

Set a container which can hold at least 8 liters (2 gal) under the drain plug (2).

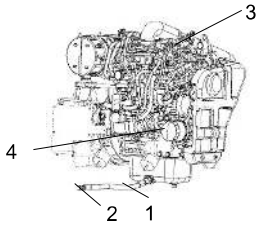
Undo the oil filler cap (3), and undo the drain plug (2) in the end of the drain hose (1). Let all the engine oil flow out.



**Deliver the drained oil to special waste handling.**



**Refer to the engine manual for detailed instructions when changing oil and filters.**



**Fig. Engine compartment, right side - D1803-CR (T4f, T5)**  
**1. Drainage hose**  
**2. Drain plug**  
**3. Filler cap**  
**4. Oil filter**

Remove the oil filter (4).

Collect any spillage.

Install the new filter.

Fit the drain plug (2) to the end of the hose.

Fill with fresh engine oil. See under the heading lubricants, for the correct oil grade. Fit the filler cap (3) and check that the oil level is correct using the dipstick.

Start the engine and allow it to idle for a few minutes. During this time, check around the oil filter and drain plug for leaks.

Switch off the engine, wait for a minute or so and then check the oil level. Top up with more oil if necessary.

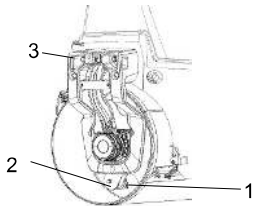
### Rubber elements and bolted joints

#### Check

Check all rubber elements (1). Replace all elements where more than 25% of the elements on one side of the drum have cracks deeper than 10-15 mm (0.4-0.6 in).

Check using a knife blade or pointed object.

Check also that the attachment screws (2) are tightened.



**Fig. Drum end**  
**1. Rubber element**  
**2. Fastening screws**  
**3. Bolted joints**



### Hydraulic reservoir cap - Check

Screw off the tank cap and check that it is not clogged. Air must have unobstructed passage through the cap in both directions.

If clogged in either direction, clean with a little diesel oil and blow with compressed air until free passage is assured or replace the cap with a new one.



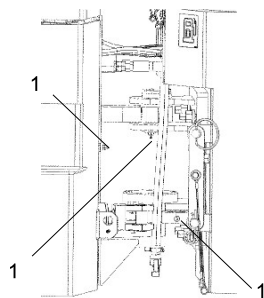
**Wear protective goggles when working with compressed air.**



### Steering cylinder and steering joint - Lubrication



**Do not allow anyone to remain in the vicinity of the steering joint when the engine is running. Danger of crush injury when the steering is operated. Activate the parking brake before lubricating.**



**Fig. Articulated joint**  
**1. Lubricant nipples**

The machine must be in neutral (straight) when lubricated. All five grease nipples (1) can now be accessed.

Wipe the grease nipples (1). Grease each nipple with five strokes of the hand-operated grease gun. Make sure that grease penetrates into the bearing. If grease does not penetrate the bearings, it may be necessary to relieve the articulation joint with a jack while repeating the greasing process.



### Check - Coolant system

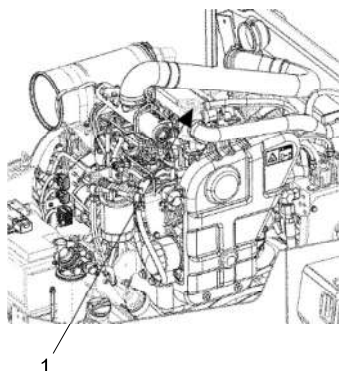
Check that all hoses/hose connectors are intact and tight. Fill with coolant as specified in the lubricants specification.



**Take great care when opening the radiator cap while the engine is hot. Wear protective gloves and goggles.**



Also check the freezing point. Change the coolant every other year.

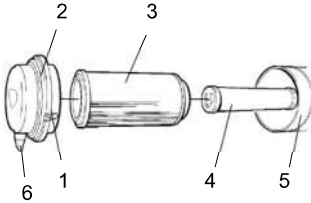


**Figure. Cooling water container**  
**1. Filler cap**



**Air cleaner****Check - Replacement of main filter**

**!** Replace the air cleaner's main filter when the indicator shows red. The indicator is mounted on the air cleaner's connecting pipe.



**Fig. Air cleaner**  
1. Clips  
2. Cover  
3. Main filter  
4. Backup filter  
5. Filter housing  
6. Dust valve

Release the clips (1), pull off the cover (2), and pull out the main filter (3).

Do not remove the backup filter (4).

Clean the air cleaner if necessary, see section Air cleaner - Cleaning.

When replacing the main filter (3), insert a new filter and refit the air cleaner in the reverse order.

Check the condition of the dust valve (6); replace if necessary.

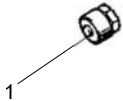
When refitting the cover, make sure that the dust valve is positioned downwards.

**Air filter indicator - Resetting**

The air filter indicator is located on the filter, or in its immediate vicinity.

The air filter indicator must be reset after replacing the air filter.

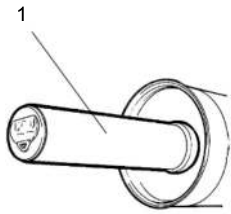
Press the "button" (1) on the top of the indicator to reset.



**Fig. Indicator**  
1. Button



### Backup filter - Change



Change the backup filter with a new filter after every third replacement of the main filter.

To change the backup filter (1), pull the old filter out of its holder, insert a new filter and reassemble the air cleaner in the reverse order.

Clean the air cleaner if necessary, see section Air cleaner - Cleaning.

*Fig. Air filter*  
**1. Backup filter**



### Replacing the hydraulic oil filter

Open the engine hood.

Loosen the red cap (1) and pull up the filter insert (4).

Refit the red cap temporarily to prevent dust and dirt getting into the tank.

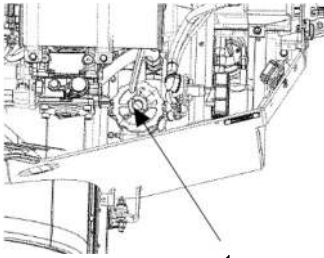


Fig. Engine compartment  
1. Filler cap

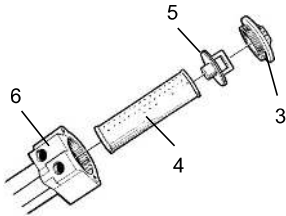


Fig. Hydraulic oil filter  
3. Cap  
4. Filter insert  
5. Handle  
6. Filter holder

Release the filter insert (4) from the handle (5).



Remove the filter (4) and hand in to a waste disposal site. This is a disposable filter and cannot be cleaned.

Mount the new insert on the handle, refit the unit into the filter holder (6), and refit the red cover.

Start the engine and allow it to run at full revs for 30 seconds. Check that the filter cap (3) is tight.

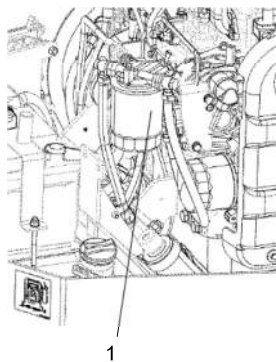
**Replacing the fuel filter**

Fig. Engine compartment, right side  
1. Fuel filter



Place a container underneath to collect fuel that runs out when the filter is released.

Screw off the fuel filter (1). The filter is of the disposable type and cannot be cleaned. Hand in to a waste disposal site.

Install the new filter.

Start the engine and check that the fuel filter is tight.



Refer to the engine manual for detailed instructions when replacing the fuel filter.



**Ensure good ventilation (air extraction) if the diesel engine is run indoors. Risk of carbon monoxide poisoning.**

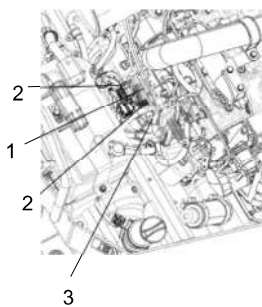
**Replacing the pre-filter**

Fig. Engine compartment -  
D1703-M-IDI-E3 (T3)  
1. Pre-filter  
2. Hose clamps  
3. Fuel pump



Place a container underneath to collect fuel that runs out when the filter is released.

Activate the parking brake.  
Switch off the engine and open the engine hood.

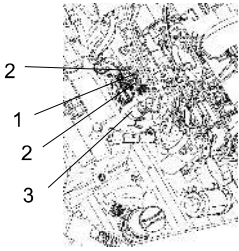


Fig. Engine compartment - D1703-M-DI-E4B (T4f, T5)  
1. Pre-filter  
2. Hose clamps  
3. Fuel pump

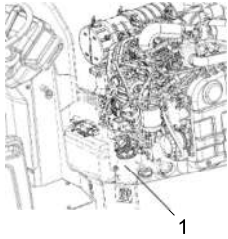


Fig. Engine compartment - D1803 CR (T4f, T5)  
1. Pre-filter

**D1703**

The prefilter is located to the left of the fuel pump in the engine compartment.

Loosen the hose clamps (2) using a screwdriver.

Remove the pre-filter (1) and hand in to a waste disposal site. This is a disposable filter and cannot be cleaned.

Fit a new pre-filter and tighten the hose clamps.

Start the engine and check that the pre-filter is tight.

**D1803**

Unscrew the fuel filter (1) located on the right side of the battery in the engine compartment.

Install a new fuel filter



**Ensure good ventilation (air extraction) if the diesel engine is run indoors. Risk of carbon monoxide poisoning.**



**Fuel tank - Cleaning**

It is easiest to clean the tank when it is almost empty.



**Pump out any bottom sediment using a suitable pump, such as an oil drain pump. Save the oil in a container and dispose of it in an approved manner.**



**Keep in mind fire risk when handling fuel.**



The fuel tank is made of plastic (polyethylene) and is recyclable.

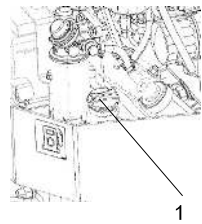
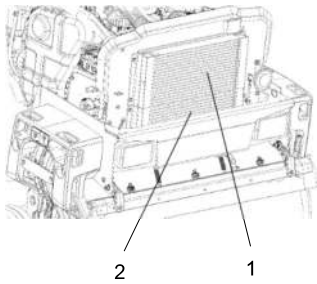


Fig. Fuel tank  
1. Fuel tank



**Fig. Engine compartment**  
1. Water cooler  
2. Hydraulic fluid cooler

### Coolers Checking - Cleaning

Make sure that the air flow through the coolers (1) and (2) is unobstructed. Dirty coolers are blown clean with compressed air or washed clean using a high-pressure water cleaner.

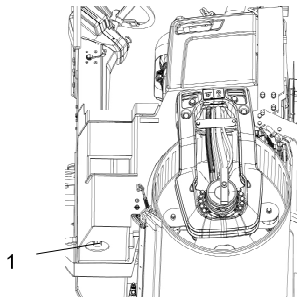
Blow air or direct water through the cooler in the opposite direction to that of the cooling air.



Take care when using a high-pressure water jet. Do not hold the nozzle too near the cooler.



***Wear protective goggles when working with compressed air or high-pressure water jets.***



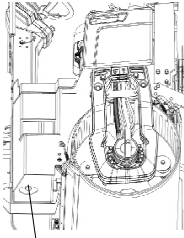
**Fig. Water tank**  
1. Drain plug

### Water tank - Draining



Remember that there is a risk of freezing during the winter. Empty the tank, pump and lines.

Remove the drain plug (1) and allow all the water to run out. Wipe clean the drain plug and screw back in.



1

*Fig. Water tank  
1. Drain plug*

### Water tank - Cleaning

Clean the tank with water and a suitable detergent for plastic surfaces.

Refit the filter housing or the drain plug (1). Fill with water and check for leaks.



The water tank is made of plastic (polyethylene) and are recyclable.

### Checking of EGR cooler

Contact your local Kubota representative for this service

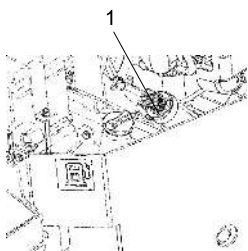
**Hydraulic reservoir - fluid change**

Fig. Hydraulic reservoir  
1. Draining

Use an external drainage pump when draining/emptying the hydraulic reservoir.



**Risk of burn injuries when draining hot oil. Wear protective gloves and goggles.**

Unscrew the tank cap. Place the pump's suction hose in the filler/drain outlet in the hydraulic tank. Place the other hose in a container.



Use a receptacle that holds at least 15 liters (4 gal).

Start the pump so that it sucks out the fluid from the tank.

Check that the hose to the pump reaches the bottom of the hydraulic reservoir to ensure that as much of the fluid as possible is drained.



Collect the oil and deliver to special waste handling.

Fill up with the recommended hydraulic fluid to the correct level. Replace the cap on the tank and wipe clean.

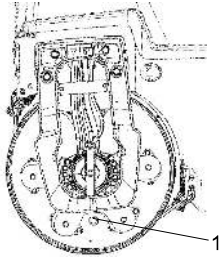
Change the hydraulic fluid filter, see under heading 'Every 1000 hours of operation'.

Start the engine and operate the various hydraulic functions. Check the level in the reservoir and top off as required.



**Drum - Oil change**

**Take great care when draining the fluid. Wear protective gloves and goggles.**



**Fig. Drum, vibration side**  
**1. Drain plug**

Place the roller on a level surface and drive it slowly until the drain plug (1) is straight down.

- Remove the oil plug (1) and allow all the oil to run out.
- Clean and refit the oil plugs (1).
- Start the machine and run until the oil plug (1) is positioned straight up.
- Remove the oil plug (1) and fill the drum with the right quantity and the type of oil according to the lubricant table.
- Refit the oil plug (1).



**Switch off the engine and activate the parking brake.**



Place a receptacle that will hold at least 7 liters (7.4 quarts) under the plug. Collect the oil and dispose of it properly.

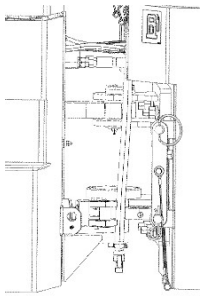


Fig. Steering joint

### Steering joint - Check

Check the steering joint for any damage or cracks.  
Check and tighten any loose bolts.  
Check also for any stiffness and play.



### Edge cutter (Optional) - Lubrication



**Refer to the operation section for information on how to operate the edge cutter.**

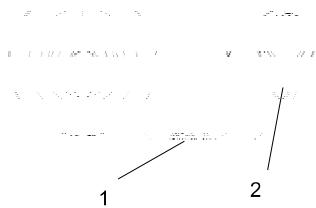


Fig. Two grease points for lubricating the edge cutter

Grease the two points as shown in the figure.

Grease should always be used for lubrication, see the lubricant specifications.

Grease all bearing points with five strokes of a hand-operated grease gun.

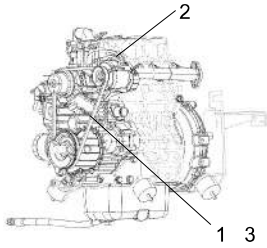
## Replacing belts/Checking the belt tension



**Exercise care to stop the engine and remove the key before checking the belt tension.**



**Exercise care to install the standalone safety shield after maintenance or inspection.**



**Fig. Diesel engine - D1703 (T4f, T5)**  
1. Belt  
2. Bolt and nut  
3. Deflection between 7 to 9 mm  
(0.28 to 0.35 in.)

Stop the engine and remove the key.

If necessary, remove the belt guard.

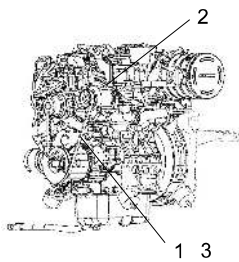
Apply a moderate pressure with your thumb on the belt, between the belt pulleys on the alternator and crankshaft, to check the belt tension. The deflection should be between 7 and 9 mm (0.28 to 0.35 in.).

If the belt tension is not sufficient: - Loosen the fastening bolts that hold the alternator in place. - Use a prybar/lever and place it between the alternator and engine block, push the alternator outwards to achieve the required belt tension.

Tighten the bolts holding the alternator with the correct torque.



**If the belt is loose or damaged, it may result in insufficient charging. Adjust or replace the belt.**



**Fig. Diesel engine - D1803 (T4f, T5)**  
1. Belt  
2. Bolt and nut  
3. Deflection between 7 to 9 mm  
(0.28 to 0.35 in.)



## Maintenance, 3000h



**Park the roller on a level surface. The engine must be switched off and the parking brake activated when checking or adjusting the roller, unless otherwise specified.**



**Ensure that there is good ventilation (air extraction) if the engine is run indoors. Risk of carbon monoxide poisoning.**

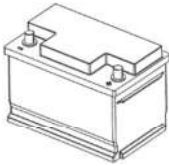


Fig. Battery

**Battery****- Check condition**

The battery is sealed and maintenance-free.



**Make sure there is no open flame in the vicinity when checking the electrolyte level. Explosive gas is formed when the alternator charges the battery.**



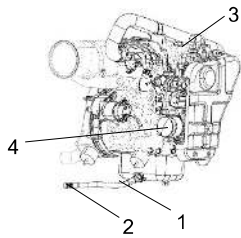
When disconnecting the battery, always disconnect the negative cable first. When connecting the battery, always connect the positive cable first.

The cable shoes should be clean and well-tightened. Corroded cable shoes should be cleaned and greased with acid-free Vaseline.

Wipe the top of the battery.

**Engine oil and oil filter - Change**

Run the engine until it is warm before draining the oil .



**Fig. Engine compartment right side - D1703-E3B (T3)**

1. Drain hose
2. Drain plug
3. Filler cap
4. Oil filter



**Switch off the engine and push in the emergency stop.**



**Take great care when draining fluids and oils. Wear protective gloves and goggles.**

Set a container which can hold at least 8 liters (2 gal) under the drain plug (2).

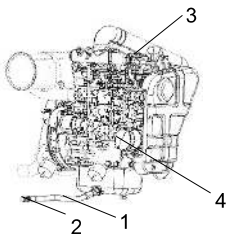
Undo the oil filler cap (3), and undo the drain plug (2) in the end of the drain hose (1). Let all the engine oil flow out.



**Deliver the drained oil to special waste handling.**

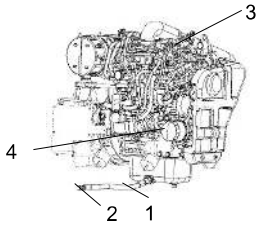


**Refer to the engine manual for detailed instructions when changing oil and filters.**



**Fig. Engine compartment, right side - D1703-E4B (T4f, T5)**

1. Drainage hose
2. Drain plug
3. Filler cap
4. Oil filter



**Fig. Engine compartment, right side - D1803-CR (T4f, T5)**  
1. Drainage hose  
2. Drain plug  
3. Filler cap  
4. Oil filter

Remove the oil filter (4).

Collect any spillage.

Install the new filter.

Fit the drain plug (2) to the end of the hose.

Fill with fresh engine oil. See under the heading lubricants, for the correct oil grade. Fit the filler cap (3) and check that the oil level is correct using the dipstick.

Start the engine and allow it to idle for a few minutes. During this time, check around the oil filter and drain plug for leaks.

Switch off the engine, wait for a minute or so and then check the oil level. Top up with more oil if necessary.

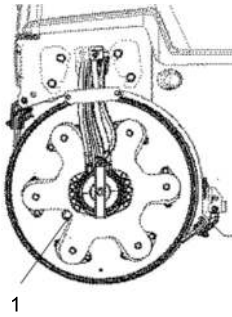


### **Drum - oil level Inspection - filling**

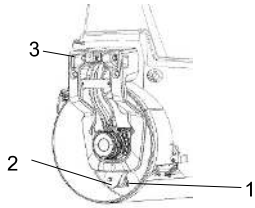
Run the roller slowly until the oil plug (1) is positioned as illustrated.

Unscrew the plug and check that the oil level reaches up to the bottom of the hole. Top up with new oil if necessary. Use oil as per the lubricant specification.

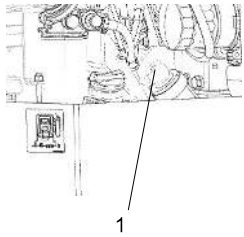
Clean the magnetic oil plug (1) from any metallic residue, and refit the plug.



**Fig. Drum vibration side**  
1. Oil plug



**Fig. Drum end**  
1. Rubber element  
2. Fastening screws  
3. Bolted joints



**Fig. Engine compartment**  
1. Tank cap, hydraulic fluid

### Rubber elements and bolted joints

#### Check

Check all rubber elements (1). Replace all elements where more than 25% of the elements on one side of the drum have cracks deeper than 10-15 mm (0.4-0.6 in).

Check using a knife blade or pointed object.

Check also that the attachment screws (2) are tightened.

### Hydraulic reservoir cap - Check

Screw off the tank cap and check that it is not clogged. Air must have unobstructed passage through the cap in both directions.

If clogged in either direction, clean with a little diesel oil and blow with compressed air until free passage is assured or replace the cap with a new one.



**Wear protective goggles when working with compressed air.**

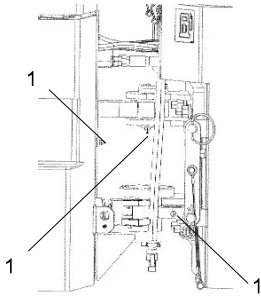




### Steering cylinder and steering joint - Lubrication



**Do not allow anyone to remain in the vicinity of the steering joint when the engine is running. Danger of crush injury when the steering is operated. Activate the parking brake before lubricating.**



**Fig. Articulated joint**  
**1. Lubricant nipples**

The machine must be in neutral (straight) when lubricated. All five grease nipples (1) can now be accessed.

Wipe the grease nipples (1). Grease each nipple with five strokes of the hand-operated grease gun. Make sure that grease penetrates into the bearing. If grease does not penetrate the bearings, it may be necessary to relieve the articulation joint with a jack while repeating the greasing process.

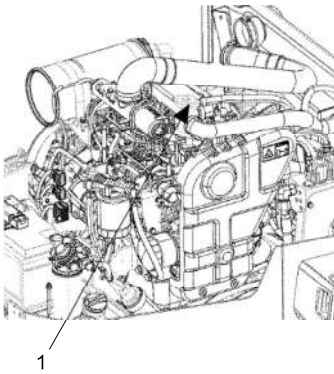


### Check - Coolant system

Check that all hoses/hose connectors are intact and tight. Fill with coolant as specified in the lubricants specification.



**Take great care when opening the radiator cap while the engine is hot. Wear protective gloves and goggles.**



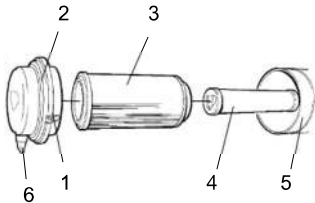
**Figure. Cooling water container**  
**1. Filler cap**



Also check the freezing point. Change the coolant every other year.

**Air cleaner****Check - Replacement of main filter**

Replace the air cleaner's main filter when the indicator shows red. The indicator is mounted on the air cleaner's connecting pipe.



**Fig. Air cleaner**  
1. Clips  
2. Cover  
3. Main filter  
4. Backup filter  
5. Filter housing  
6. Dust valve

Release the clips (1), pull off the cover (2), and pull out the main filter (3).

Do not remove the backup filter (4).

Clean the air cleaner if necessary, see section Air cleaner - Cleaning.

When replacing the main filter (3), insert a new filter and refit the air cleaner in the reverse order.

Check the condition of the dust valve (6); replace if necessary.

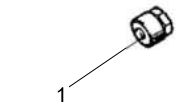
When refitting the cover, make sure that the dust valve is positioned downwards.

**Air filter indicator - Resetting**

The air filter indicator is located on the filter, or in its immediate vicinity.

The air filter indicator must be reset after replacing the air filter.

Press the "button" (1) on the top of the indicator to reset.



**Fig. Indicator**  
1. Button



### Backup filter - Change

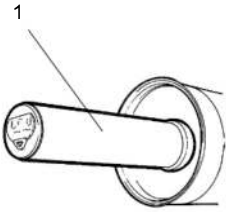


Fig. Air filter  
1. Backup filter

Change the backup filter with a new filter after every third replacement of the main filter.

To change the backup filter (1), pull the old filter out of its holder, insert a new filter and reassemble the air cleaner in the reverse order.

Clean the air cleaner if necessary, see section Air cleaner - Cleaning.



### Water tank - Cleaning

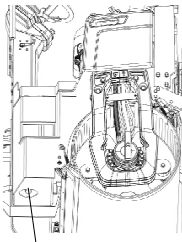


Fig. Water tank  
1. Drain plug

Clean the tank with water and a suitable detergent for plastic surfaces.

Refit the filter housing or the drain plug (1). Fill with water and check for leaks.



The water tank is made of plastic (polyethylene) and are recyclable.



### Replacing the hydraulic oil filter

Open the engine hood.

Loosen the red cap (1) and pull up the filter insert (4).

Refit the red cap temporarily to prevent dust and dirt getting into the tank.

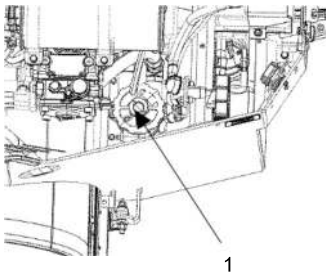


Fig. Engine compartment  
1. Filter cap

Release the filter insert (4) from the handle (5).



Remove the filter (4) and hand in to a waste disposal site. This is a disposable filter and cannot be cleaned.

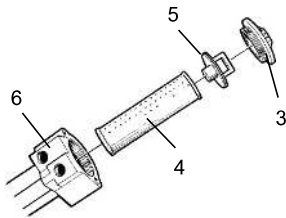


Fig. Hydraulic oil filter  
3. Cap  
4. Filter insert  
5. Handle  
6. Filter holder

Mount the new insert on the handle, refit the unit into the filter holder (6), and refit the red cover.

Start the engine and allow it to run at full revs for 30 seconds. Check that the filter cap (3) is tight.

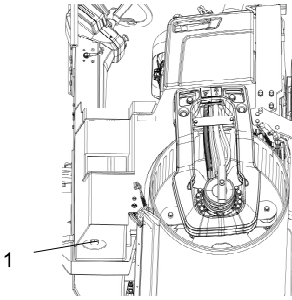


## Water tank - Draining



Remember that there is a risk of freezing during the winter. Empty the tank, pump and lines.

Remove the drain plug (1) and allow all the water to run out. Wipe clean the drain plug and screw back in.



**Fig. Water tank**  
**1. Drain plug**

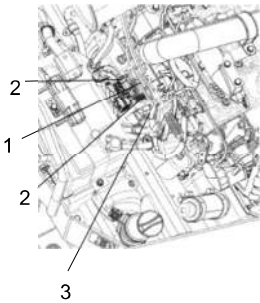


## Replacing the pre-filter

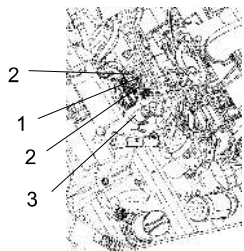
Activate the parking brake.  
Switch off the engine and open the engine hood.



Place a container underneath to collect fuel that runs out when the filter is released.

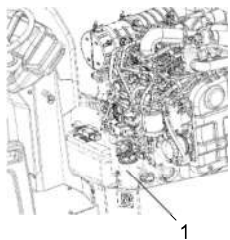


**Fig. Engine compartment -**  
**D1703-M-IDI-E3 (T3)**  
**1. Pre-filter**  
**2. Hose clamps**  
**3. Fuel pump**



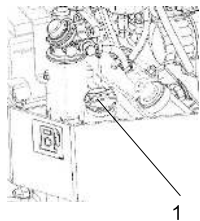
**Fig. Engine compartment - D1703-M-DI-E4B (T4f, T5)**

1. Pre-filter
2. Hose clamps
3. Fuel pump



**Fig. Engine compartment - D1803 CR (T4f, T5)**

1. Pre-filter



**Fig. Fuel tank**  
1. Fuel tank

### D1703

The prefilter is located to the left of the fuel pump in the engine compartment.

Loosen the hose clamps (2) using a screwdriver.

Remove the pre-filter (1) and hand in to a waste disposal site. This is a disposable filter and cannot be cleaned.

Fit a new pre-filter and tighten the hose clamps.

Start the engine and check that the pre-filter is tight.

### D1803

Unscrew the fuel filter (1) located on the right side of the battery in the engine compartment.

Install a new fuel filter



**Ensure good ventilation (air extraction) if the diesel engine is run indoors. Risk of carbon monoxide poisoning.**

### Fuel tank - Cleaning

It is easiest to clean the tank when it is almost empty.



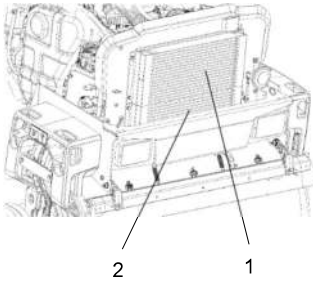
**Pump out any bottom sediment using a suitable pump, such as an oil drain pump. Save the oil in a container and dispose of it in an approved manner.**



**Keep in mind fire risk when handling fuel.**



The fuel tank is made of plastic (polyethylene) and is recyclable.



**Fig. Engine compartment**  
1. Water cooler  
2. Hydraulic fluid cooler

### **Coolers** **Checking - Cleaning**

Make sure that the air flow through the coolers (1) and (2) is unobstructed. Dirty coolers are blown clean with compressed air or washed clean using a high-pressure water cleaner.

Blow air or direct water through the cooler in the opposite direction to that of the cooling air.



Take care when using a high-pressure water jet. Do not hold the nozzle too near the cooler.



***Wear protective goggles when working with compressed air or high-pressure water jets.***

### **Checking of EGR cooler**

Contact your local Kubota representative for this service

**Replacing the fuel filter**

Place a container underneath to collect fuel that runs out when the filter is released.

Screw off the fuel filter (1). The filter is of the disposable type and cannot be cleaned. Hand in to a waste disposal site.

Install the new filter.

Start the engine and check that the fuel filter is tight.



Refer to the engine manual for detailed instructions when replacing the fuel filter.



**Ensure good ventilation (air extraction) if the diesel engine is run indoors. Risk of carbon monoxide poisoning.**

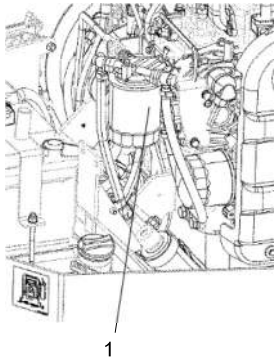


Fig. Engine compartment, right side  
1. Fuel filter



**Hydraulic reservoir - fluid change**

Use an external drainage pump when draining/emptying the hydraulic reservoir.

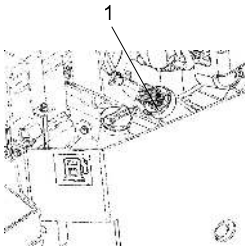


***Risk of burn injuries when draining hot oil. Wear protective gloves and goggles.***

Unscrew the tank cap. Place the pump's suction hose in the filler/drain outlet in the hydraulic tank. Place the other hose in a container.



Use a receptacle that holds at least 15 liters (4 gal).



**Fig. Hydraulic reservoir  
1. Draining**

Start the pump so that it sucks out the fluid from the tank.

Check that the hose to the pump reaches the bottom of the hydraulic reservoir to ensure that as much of the fluid as possible is drained.



Collect the oil and deliver to special waste handling.

Fill up with the recommended hydraulic fluid to the correct level. Replace the cap on the tank and wipe clean.

Change the hydraulic fluid filter, see under heading 'Every 1000 hours of operation'.

Start the engine and operate the various hydraulic functions. Check the level in the reservoir and top off as required.

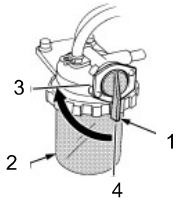


Fig. Fuel filter  
1. Filter knob  
2. Filter element  
3. OFF  
1. ON

### Draining of water separator

Close the fuel filter knob (1).

Remove the top cap and rinse the inside with diesel fuel.

Remove filter element (2) and rinse the inside with diesel fuel.

After cleaning, install the fuel filter, to keep out of dust and dirt.

Air-bleed the injection pump.



Dust and dirt may cause a injection pump and nozzle failure. Wash the fuel filter cup periodically.

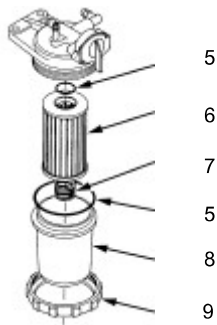
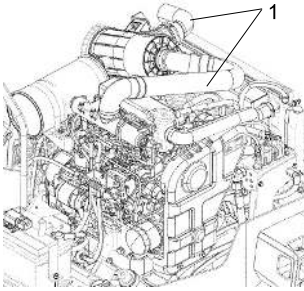


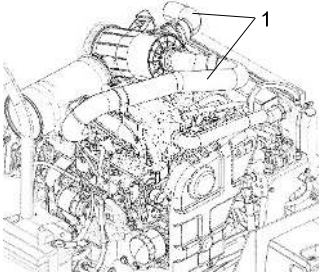
Fig. Fuel filter element  
5. O-ring  
6. Filter element  
7. Spring  
8. Filter  
9. Screw ring

**Check - Air intake hoses**

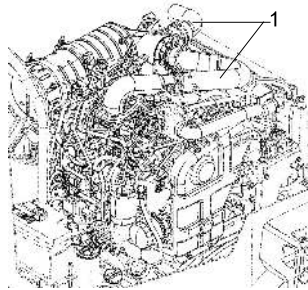
Check that all hoses/hose connections are intact and tight.



*Fig. Engine compartment -  
D1703-M-DI-E4B (T4f, T5)*  
1. Air intake hoses



*Fig. Engine compartment -  
D1703-M-DI-E3 (T3)*  
1. Air intake hoses



*Fig. Engine compartment - D1803 CR  
(T4f, T5)*  
1. Air intake hoses

**Cleaning of DPF (D1803 only)**

Contact your local Kubota representative for this service

**Checking the EGR system (only D1803)**

Contact your local Kubota representative for this service

**Checking the injection pump (only D1703)**

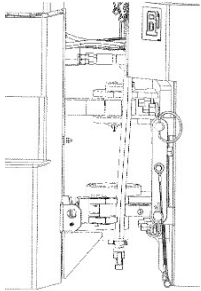
Contact your local Kubota representative for this service

**Steering joint - Check**

Check the steering joint for any damage or cracks.

Check and tighten any loose bolts.

Check also for any stiffness and play.



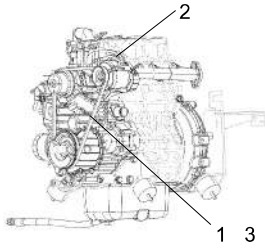
**Fig. Steering joint**

**Replacing belts/Checking the belt tension**

**Exercise care to stop the engine and remove the key before checking the belt tension.**



**Exercise care to install the standalone safety shield after maintenance or inspection.**



**Fig. Diesel engine - D1703 (T4f, T5)**  
1. Belt  
2. Bolt and nut  
3. Deflection between 7 to 9 mm  
(0.28 to 0.35 in.)

Stop the engine and remove the key.

If necessary, remove the belt guard.

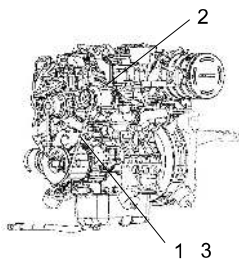
Apply a moderate pressure with your thumb on the belt, between the belt pulleys on the alternator and crankshaft, to check the belt tension. The deflection should be between 7 and 9 mm (0.28 to 0.35 in.).

If the belt tension is not sufficient: - Loosen the fastening bolts that hold the alternator in place. - Use a prybar/lever and place it between the alternator and engine block, push the alternator outwards to achieve the required belt tension.

Tighten the bolts holding the alternator with the correct torque.



**If the belt is loose or damaged, it may result in insufficient charging. Adjust or replace the belt.**



**Fig. Diesel engine - D1803 (T4f, T5)**  
1. Belt  
2. Bolt and nut  
3. Deflection between 7 to 9 mm  
(0.28 to 0.35 in.)



**Maintenance, every 12th month (Annually)****Air cleaner  
Check - Replacement of main filter**

Replace the air cleaner's main filter when the indicator shows red. The indicator is mounted on the air cleaner's connecting pipe.

**Air filter indicator - Resetting**

The air filter indicator is located on the filter, or in its immediate vicinity.

The air filter indicator must be reset after replacing the air filter.

Press the "button" (1) on the top of the indicator to reset.

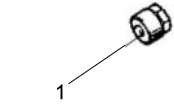


Fig. Indicator  
1. Button

**Backup filter - Change**

Change the backup filter with a new filter after every third replacement of the main filter.

To change the backup filter (1), pull the old filter out of its holder, insert a new filter and reassemble the air cleaner in the reverse order.

Clean the air cleaner if necessary, see section Air cleaner - Cleaning.

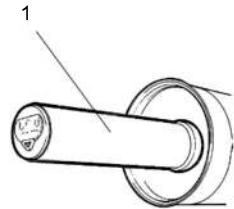


Fig. Air filter  
1. Backup filter

**Checking the DPF pipes and connections  
(only D1803)**

Contact your local Kubota representative for this service

## Maintenance, every 12th month (Annually)

---

### **Checking the EGR pipes and connections (only D1803)**

Contact your local Kubota representative for this service

### **Check the Manifold (only D1803)**

Contact your local Kubota representative for this service



Maintenance, every 24th month (Every other year)



Check - Coolant system

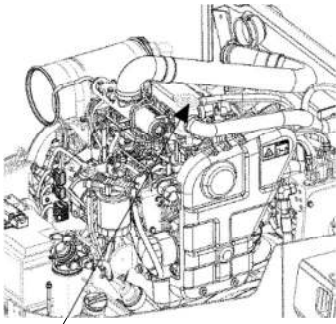
Check that all hoses/hose connectors are intact and tight. Fill with coolant as specified in the lubricants specification.



**Take great care when opening the radiator cap while the engine is hot. Wear protective gloves and goggles.**



Also check the freezing point. Change the coolant every other year.

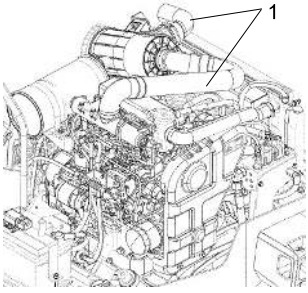


1

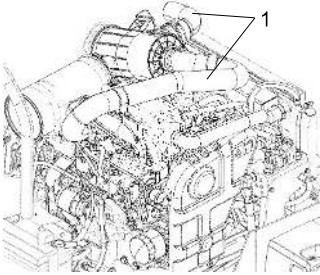
Figure. Cooling water container  
1. Filler cap

**Check - Air intake hoses**

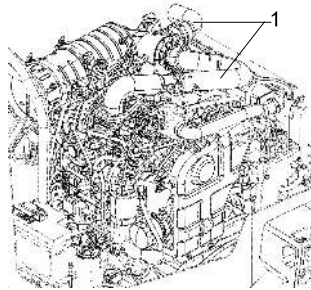
Check that all hoses/hose connections are intact and tight.



**Fig. Engine compartment -  
D1703-M-DI-E4B (T4f, T5)**  
1. Air intake hoses



**Fig. Engine compartment -  
D1703-M-DI-E3 (T3)**  
1. Air intake hoses



**Fig. Engine compartment - D1803 CR  
(T4f, T5)**  
1. Air intake hoses





**Dynapac Compaction Equipment AB**  
Box 504, SE 371 23 Karlskrona, Sweden

[www.dynapac.com](http://www.dynapac.com)