

Introduction



Danger

Failure to obey the instructions and safety rules in this manual will result in death or serious injury.

Do Not Operate Unless:

- You learn and practice the principles of safe machine operation contained in this operator's manual.
 - 1 Avoid hazardous situations.**
 - Know and understand the safety rules before going on to the next section.**
 - 2 Always perform a pre-operation inspection.
 - 3 Always perform function tests prior to use.
 - 4 Inspect the workplace.
 - 5 Only use the machine as it was intended.
- You read, understand and obey the manufacturer's instructions and safety rules—safety and operator's manuals and machine decals.
- You read, understand and obey employer's safety rules and worksite regulations.
- You read, understand and obey all applicable governmental regulations.
- You are properly trained to safely operate the machine.

Introduction

Safety Sign Maintenance

Replace any missing or damaged safety signs. Keep operator safety in mind at all times. Use mild soap and water to clean safety signs. Do not use solvent-based cleaners because they may damage the safety sign material.

Hazard Classification

Decals on this machine use symbols, color coding and signal words to identify the following:



Safety alert symbol—used to alert you to potential personal injury hazards. Obey all safety messages that follow this symbol to avoid possible injury or death.

▲ DANGER

Indicates a hazardous situation which, if not avoided, will result in death or serious injury.

▲ WARNING

Indicates a hazardous situation which, if not avoided, could result in death or serious injury.









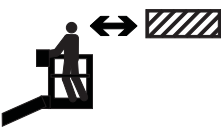

▲ CAUTION

Indicates a hazardous situation which, if not avoided, could result in minor or moderate injury.





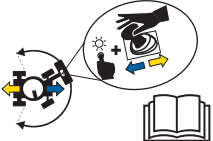
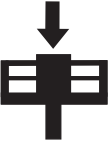
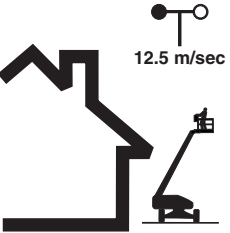



NOTICE

Indicates a property damage message.

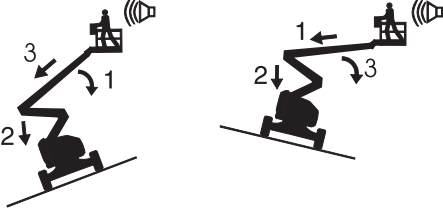
Symbol and Hazard Pictorials Definitions

				
Crush hazard	Explosion hazard	Collision hazard	Collision hazard	Runaway Hazard
				
Tip-over hazard	Tip-over hazard	Raise platform on firm, level surface	Electrocution hazard	Maintain required clearance
				
Color Coded Direction Arrows	Maximum capacity	Wind speed	Manual force	Only trained maintenance personnel should access compartments

Symbol and Hazard Pictorials Definitions

 <p>No smoking No flame Stop engine</p>	 <p>Read the operator's manual</p>	<p>Recovery procedure if tilt alarm sounds while elevated.</p>  <p>Platform uphill: 1 Lower primary 2 Lower secondary 3 Retract primary</p> <p>Platform downhill: 1 Retract primary 2 Lower secondary 3 Lower primary</p>		 <p>Wheel load</p>
 <p>Lanyard attachment point</p>	 <p>Replace tires with tires of same specification.</p>	 <p>Voltage rating for power to platform</p>	 <p>Pressure rating for air line to platform</p>	

General Safety

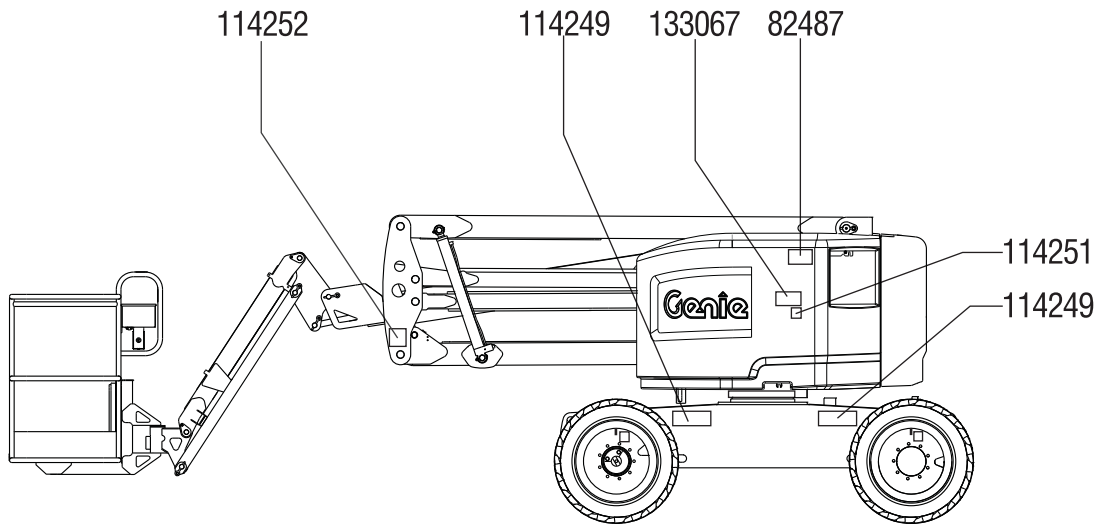

133067



114252

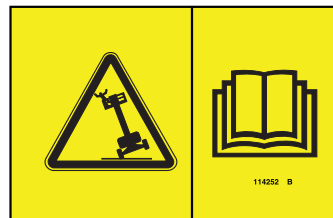

82487



114251



114249

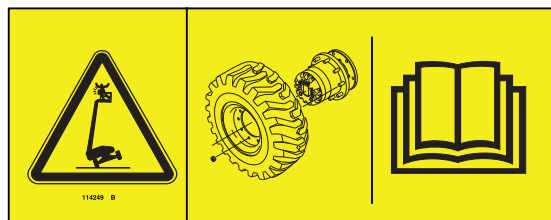

General Safety

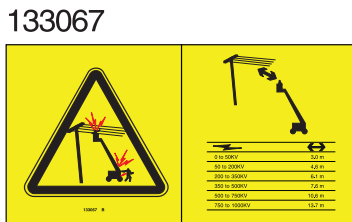
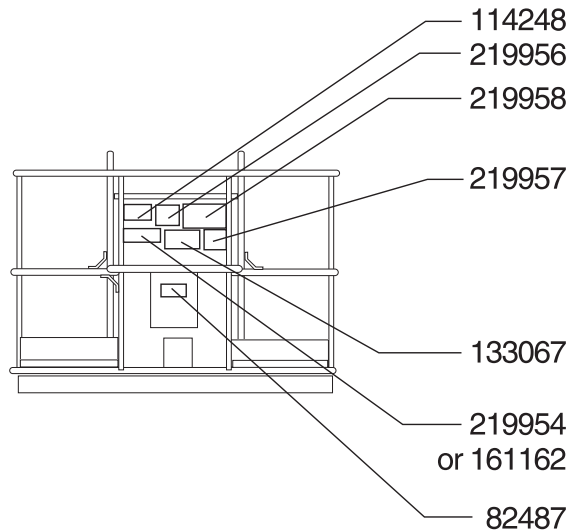
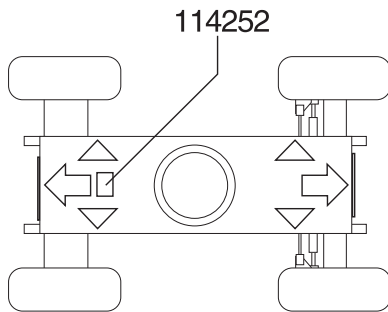

General Safety

114252

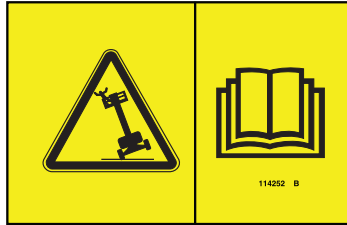

133067

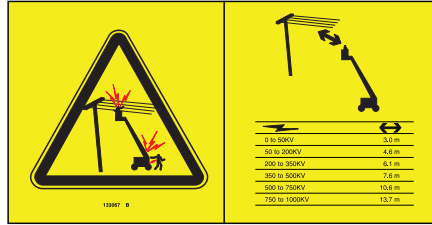

82473

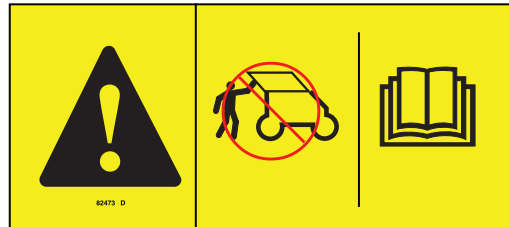

114249

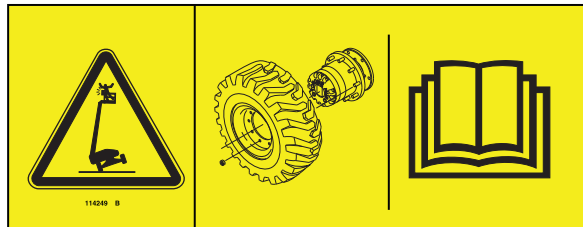

82481



114252

133067

82481

82473

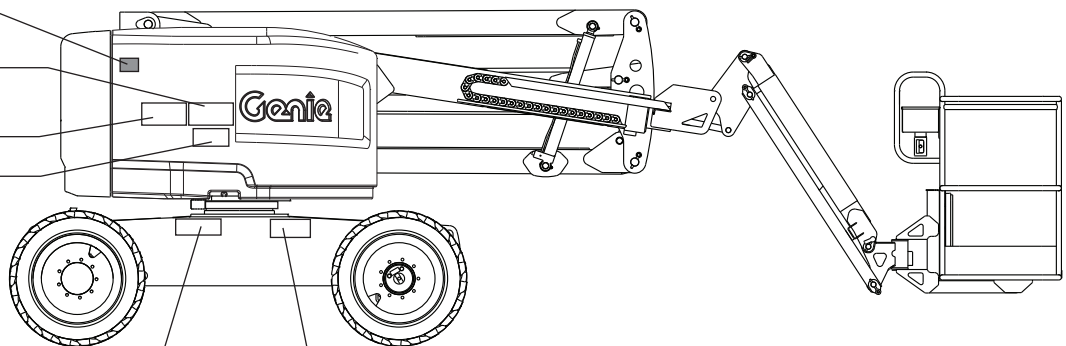

114249

114249

Personal Safety

Personal Fall Protection

Personal fall protection equipment (PFPE) is required when operating this machine.

Occupants must wear a safety belt or harness in accordance with governmental regulations. Attach the lanyard to the anchor provided in the platform.

Operators must comply with employer, job site and governmental rules regarding the use of personal protective equipment.

All PFPE must comply with applicable governmental regulations, and must be inspected and used in accordance with the PFPE manufacturer's instructions.

Work Area Safety

⚠ Electrocuting Hazards

This machine is not electrically insulated and will not provide protection from contact with or proximity to electrical current.



Obey all local and governmental regulations regarding required clearance from electrical power lines. At a minimum, the required clearance contained in the chart below must be followed.

Line Voltage	Required Clearance
0 to 50KV	3.05 m
50 to 200KV	4.60 m
200 to 350KV	6.10 m
350 to 500KV	7.62 m
500 to 750KV	10.67 m
750 to 1000KV	13.72 m

Allow for platform movement, electrical line sway or sag, and beware of strong or gusty winds.

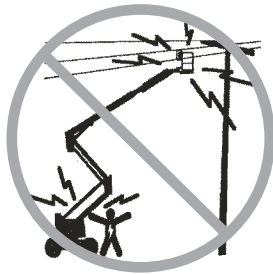

Keep away from the machine if it contacts energized power lines. Personnel on the ground or in the platform must not touch or operate the machine until energized power lines are shut off.

Do not operate the machine during lightning or storms.

Do not use the machine as a ground for welding.

⚠ Tip-over Hazards

Occupants, equipment and materials shall not exceed the maximum platform capacity or the maximum platform capacity of the platform extension.

Maximum platform capacity	227 kg
Machine equipped with Aircraft Protection Package	200 kg
Maximum occupants	2

The weight of options and accessories, such as pipe cradles, panel cradles and welders, will reduce the rated platform capacity and must be subtracted from the platform capacity. See the decals with the options and accessories.

If using accessories, read, understand and obey the decals, instructions and manuals with the accessory.



Do not raise or extend the boom unless the machine is on a firm, level surface.



Work Area Safety

Do not depend on the tilt alarm as a level indicator. The tilt alarm sounds in the platform only when the machine is on a severe slope.

If the tilt alarm sounds while the boom is lowered: Do not extend, rotate or raise the boom above horizontal. Move the machine to a firm, level surface before raising the platform.

If the tilt alarm sounds when the platform is raised, use extreme caution. Identify the condition of the boom on the slope as shown below. Follow the steps to lower the boom before moving to a firm, level surface. Do not rotate the boom while lowering.

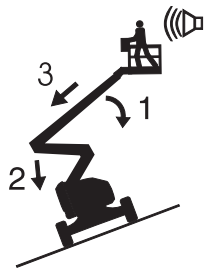

If the tilt alarm sounds with the platform uphill:

- 1 Lower the primary boom.
- 2 Lower the secondary boom.
- 3 Retract the primary boom.

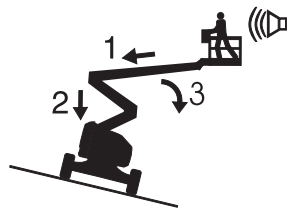

If the tilt alarm sounds with the platform downhill:

- 1 Retract the primary boom.
- 2 Lower the secondary boom.
- 3 Lower the primary boom.

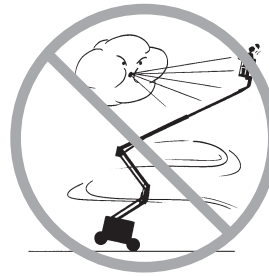

Do not raise the boom when wind speeds may exceed 12.5 m/s. If wind speeds exceed 12.5 m/s when the boom is raised, lower the boom and do not continue to operate the machine.

Do not operate the machine in strong or gusty winds. Do not increase the surface area of the platform or the load. Increasing the area exposed to the wind will decrease machine stability.



Use extreme care and slow speeds while driving the machine in the stowed position across uneven terrain, debris, unstable or slippery surfaces and near holes and drop-offs.

Do not drive the machine on or near uneven terrain, unstable surfaces or other hazardous conditions with the boom raised or extended.

Do not use the machine as a crane.

Do not push the machine or other objects with the boom.

Do not contact adjacent structures with the boom.

Work Area Safety

Do not tie the boom or platform to adjacent structures.

Do not place loads outside the platform perimeter.

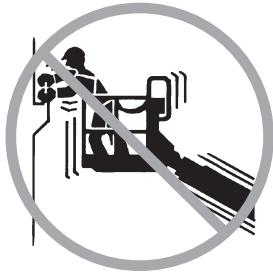

Do not push off or pull toward any object outside of the platform.

Maximum allowable manual force – 400 N

Do not replace factory-installed tires with tires of different specification or ply rating.

Z-51/30J models: Do not use air-filled tires. These machines are equipped with foam-filled tires. Wheel weight and proper counterweight configuration are critical to stability.

Z-45/25 and Z-45/25J models equipped with Aircraft Protection Package: Do not use air-filled tires. These machines are equipped with foam-filled tires. Wheel weight is critical to stability.

Do not modify or alter an aerial work platform without prior written permission from the manufacturer. Mounting attachments for holding tools or other materials onto the platform, toeboards or guard rail system can increase the weight in the platform and the surface area of the platform or the load.



Do not place or attach fixed or overhanging loads to any part of this machine.



Do not place ladders or scaffolds in the platform or against any part of this machine.

Do not transport tools and materials unless they are evenly distributed and can be safely handled by person(s) in the platform.

Do not use the machine on a moving or mobile surface or vehicle.

Be sure all tires are in good condition, air-filled tires are properly inflated and lug nuts are properly tightened.

Do not use the platform controls to free a platform that is caught, snagged or otherwise prevented from normal motion by an adjacent structure. All personnel must be removed from the platform before attempting to free the platform using the ground controls.

Work Area Safety

⚠ Operation on Slopes Hazards

Do not drive the machine on a slope that exceeds the maximum uphill, downhill or side slope rating of the machine. Slope rating applies only to machines in the stowed position.

Maximum slope rating, stowed position, 2WD

Platform downhill	30%	(17°)
Platform uphill	25%	(14°)
Side slope	25%	(14°)

Maximum slope rating, stowed position, 4WD

Platform downhill	45%	(24°)
Platform uphill	25%	(14°)
Side slope	25%	(14°)

Note: Slope rating is subject to ground conditions and adequate traction. See Driving on a Slope in the Operating Instructions section.

⚠ Fall Hazards

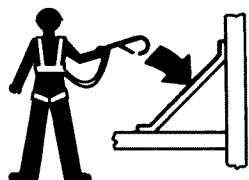

Occupants must wear a safety belt or harness in accordance with governmental regulations. Attach the lanyard to the anchor provided in the platform.



Do not sit, stand or climb on the platform guard rails. Maintain a firm footing on the platform floor at all times.



Do not climb down from the platform when raised.

Keep the platform floor clear of debris.

Lower the platform entry mid-rail or close the entry gate before operating.

Do not enter or exit the platform unless the machine is in the stowed position and the platform is at ground level.

⚠ Collision Hazards

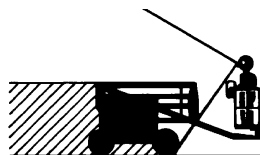

Be aware of limited sight distance and blind spots when driving or operating.

Be aware of the boom position and tailswing when rotating the turntable.



Check the work area for overhead obstructions or other possible hazards.

Work Area Safety



Be aware of crushing hazards when grasping the platform guard rail.

Operators must comply with employer, job site and governmental rules regarding use of personal protective equipment.

Observe and use the color-coded direction arrows on the platform controls and drive chassis for drive and steer functions.



Do not lower the boom unless the area below is clear of personnel and obstructions.



Limit travel speed according to the condition of the ground surface, congestion, slope, location of personnel, and any other factors which may cause collision.

Do not operate a boom in the path of any crane unless the controls of the crane have been locked out and/or precautions have been taken to prevent any potential collision.

No stunt driving or horseplay while operating a machine.

▲ Bodily Injury Hazard

Always operate the machine in a well-ventilated area to avoid carbon monoxide poisoning.

Do not operate the machine with a hydraulic oil or air leak. An air leak or hydraulic leak can penetrate and/or burn skin.

Improper contact with components under any cover will cause serious injury. Only trained maintenance personnel should access compartments. Access by the operator is only advised when performing a pre-operation inspection. All compartments must remain closed and secured during operation.

▲ Explosion and Fire Hazards

Do not start the engine if you smell or detect liquid petroleum gas (LPG), gasoline, diesel fuel or other explosive substances.

Do not refuel the machine with the engine running.

Refuel the machine and charge the battery only in an open, well-ventilated area away from sparks, flames and lighted tobacco.

Do not operate the machine or charge the battery in hazardous locations or locations where potentially flammable or explosive gases or particles may be present.

Do not spray ether into engines equipped with glow plugs.

Work Area Safety

⚠ Damaged Machine Hazards

Do not use a damaged or malfunctioning machine.

Conduct a thorough pre-operation inspection of the machine and test all functions before each work shift. Immediately tag and remove from service a damaged or malfunctioning machine.

Be sure all maintenance has been performed as specified in this manual and the appropriate Genie service manual.

Be sure all decals are in place and legible.

Be sure the operator's, safety and responsibilities manuals are complete, legible and in the storage container located on the platform.

⚠ Component Damage Hazards

Do not use any battery or charger greater than 12V to jump-start the engine.

Do not use the machine as a ground for welding.

Do not operate the machine in locations where extremely high magnetic fields may be present.

⚠ Battery Safety

Burn Hazards



Batteries contain acid. Always wear protective clothing and eye wear when working with batteries.

Avoid spilling or contacting battery acid. Neutralize battery acid spills with baking soda and water.

Explosion Hazards



Keep sparks, flames and lighted tobacco away from batteries. Batteries emit explosive gas.

⚠ Electrocution Hazard

Avoid contact with electrical terminals.

Lockout After Each Use

- 1 Select a safe parking location—firm level surface, clear of obstruction and traffic.
- 2 Retract and lower the boom to the stowed position.
- 3 Rotate the turntable so that the boom is between the non-steer wheels.
- 4 Turn the key switch to the off position and remove the key to secure from unauthorized use.
- 5 Chock the wheels.

Work Area Safety

▲ Panel Cradle Safety

Read, understand and obey all warnings and instructions provided with the panel cradles.

Do not exceed the rated platform capacity. The combined weight of the cradles, panels, occupants, tools and any other equipment must not exceed rated capacity.

The panel cradle assembly weighs 13.6 kg.

The maximum capacity of the panel cradles is 113 kg.

The weight of the panel cradles and the load in the panel cradles may limit the maximum number of occupants in platform to one person.

Secure the cradles to the platform. Secure the panel(s) to the platform railing using the straps provided.

Do not operate unless you are adequately instructed and are aware of all hazards associated with lifting panels.

Do not cause a horizontal force or side load to machine by raising or lowering a fixed or overhanging load.

Maximum vertical height of panels: 1.2 m

Maximum wind speed: 6.7 m/sec

Maximum panel area: 3 m²

▲ Pipe Cradle Safety

Read, understand and obey all warnings and instructions provided with the pipe cradles.

Do not exceed the rated platform capacity. The pipe cradle assembly and the weight in the pipe cradles will reduce rated platform capacity and must be factored into total platform load.

The pipe cradle assembly weighs 9.5 kg.

The maximum capacity of the pipe cradle assembly is 91 kg.

The weight of the pipe cradle assembly and the load in the pipe cradles may limit the maximum number of occupants in platform.

Center the load within the perimeter of the platform.

Secure the load to the platform.

Do not obstruct the entrance or the exit of the platform.

Do not obstruct the ability to operate the platform controls or the red Emergency Stop button.

Do not operate unless you are adequately instructed and are aware of all of the hazards associated with movement of the platform with an overhanging load.

Do not cause a horizontal force or side load to machine by raising or lowering a fixed or overhanging load.

Electrocution Hazard: Keep pipes away from all energized electrical conductors.