



**SUBARU**

**Industrial Power Products**

# PTX series

**201/301/401 201T/301T**  
**201ST/301ST 201H 201D/301D**  
**210/310/220/320**  
**210ST/310ST/220ST/320ST**



<i>INSTRUCTIONS FOR USE</i>	Original	EN
<i>MANUEL D'UTILISATION</i>		FR
<i>BEDIENUNGSANLEITUNG</i>		DE
<i>GEBRUIKSAANWIJZING</i>		NL
<i>MANUAL DE INSTRUCCIONES</i>		ES
<i>MANUALE D'USO E MANUTENZIONE</i>		IT
<i>MANUAL DE INSTRUÇÕES</i>		PT
<i>ΟΔΗΓΙΕΣ ΧΡΗΣΕΩΣ ΚΑΙ ΣΥΝΤΗΡΗΣΕΩΣ ΚΙΝΗΤΗΡΩΝ</i>		GR
<i>INSTRUKTIONSBOK</i>		NO
<i>BRUKSANVISNING</i>		SE
<i>KÄYTTÖ-JA HUOLTO-OHJEET</i>		FI
<i>BRUGSANVISNING</i>		DK
<i>РУКОВОДСТВО ПО ЭКСПЛУАТАЦИИ</i>		RU
<i>إرشادات الإستعمال</i>		AR

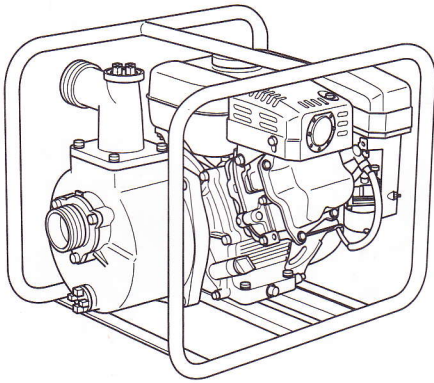

9ZZ9990103

# Robin Pump

1

PTX201,301,401, 201H, 201ST, 301ST,  
210, 310, 220, 320,  
210ST, 310ST, 220ST, 320ST

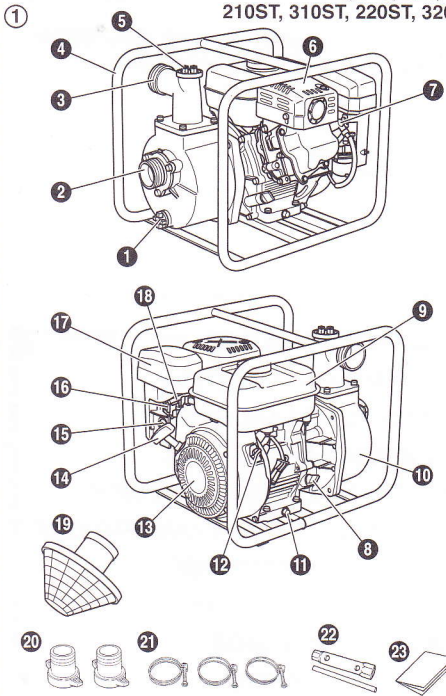

2

PTX201T, 301T

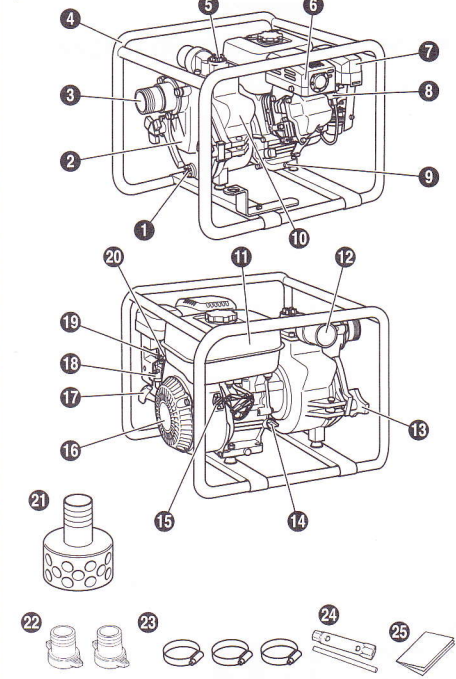

PTX201D, 301D

3

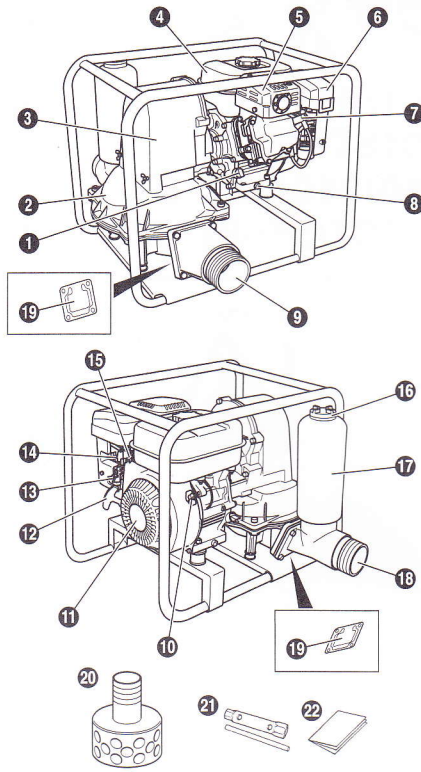

2

1

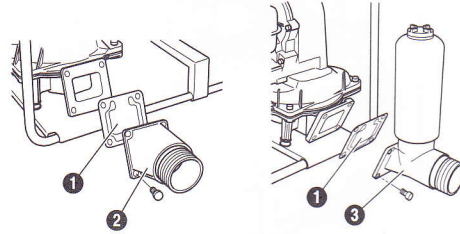

2

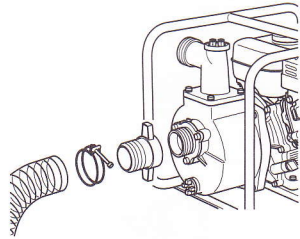

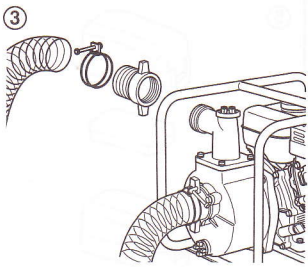

4

Single grade	5W	10W	20W	#20	#30	#40	
Multi grade	10W-30						
	10W-40						
Ambient temperature	-20	-10	0	10	20	30	40°C
	-4	14	32	50	68	86	104°F

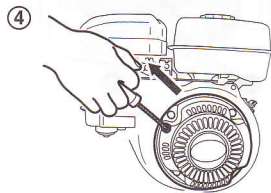
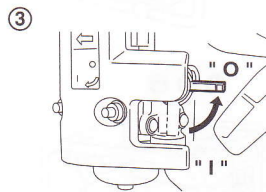
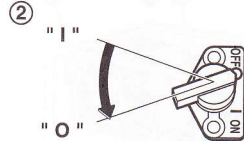
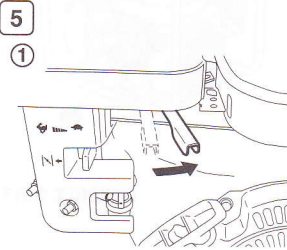
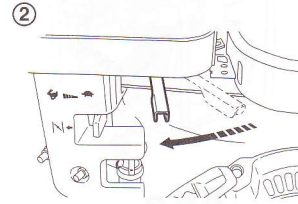
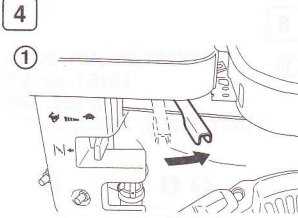
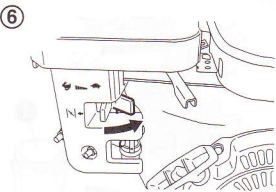
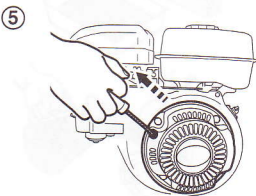
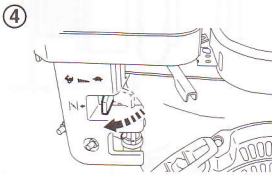
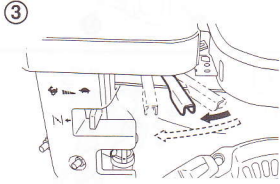
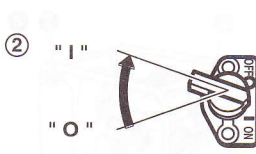
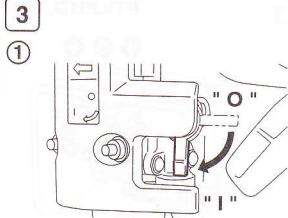
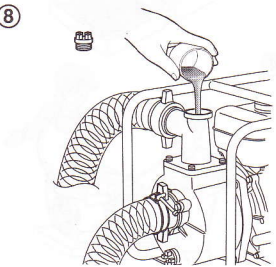
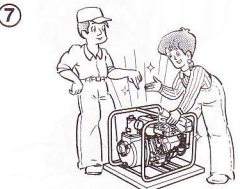
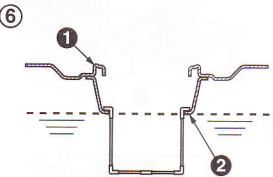
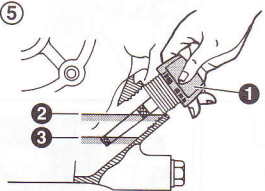

6

1

PTX201,301,401, 201H,  
201ST, 301ST,  
210, 310, 220, 320,  
210ST, 310ST, 220ST, 320ST

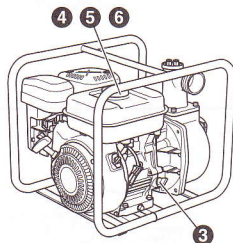
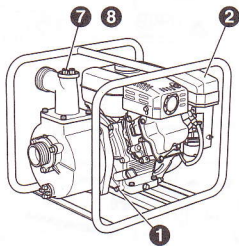

2

PTX201T, 301T

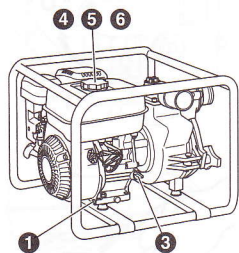
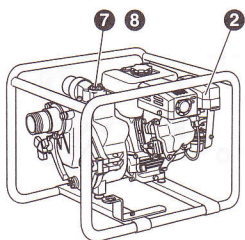

3

PTX201D, 301D

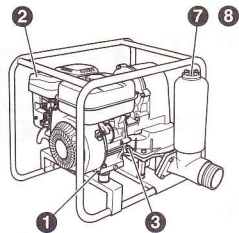
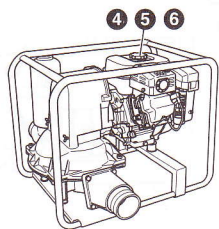

7

1

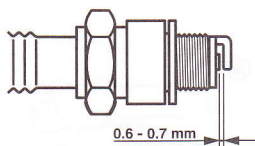

2

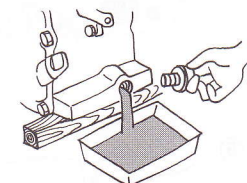

3

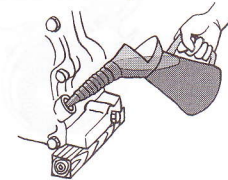

4

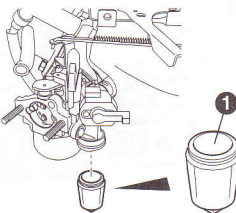

5

6

7

8

1

2

3

4

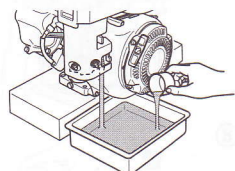
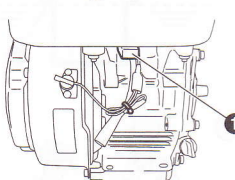
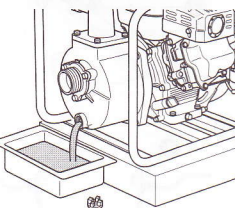

- EN CE symbol label
- FR Étiquette du symbole CE
- DE ETIKETT für CE-Symbole
- NL Etiket voor CE-symbolen

- ES Etiqueta con el símbolo CE
- IT Etichetta per simbolo CE
- PT Etiqueta com o símbolo CE
- GR Ετικέτα με το σύμβολο CE

- NO CE-symbolmerke
- SE CE-märkeskilt
- FI CE-tunnustarra
- DK CE-mærkeskilt

PTX201, 301, 401  
 PTX201H  
 PTX201ST, 301ST  
 PTX210, 310, 220, 320  
 PTX210ST, 310ST,  
 220ST, 320ST

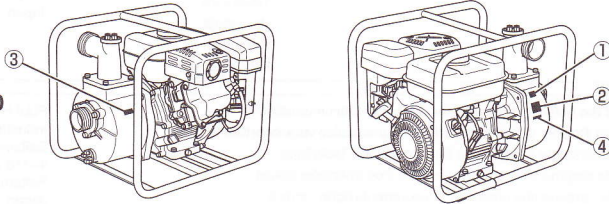

PTX201T

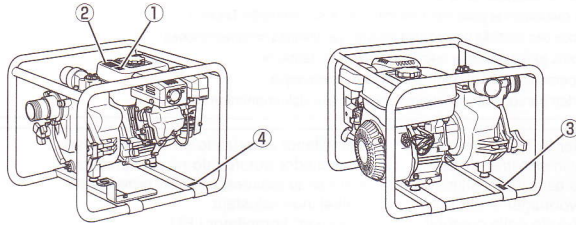

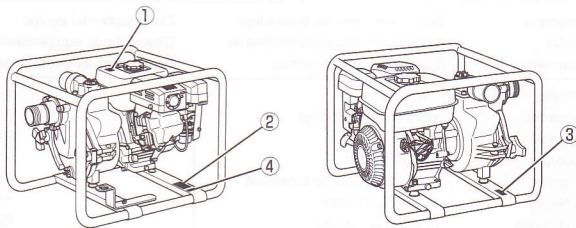

PTX301T

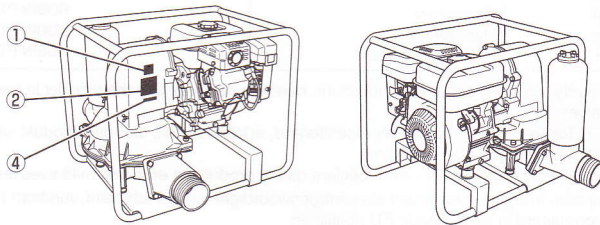

PTX201D, 301D

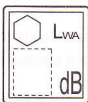
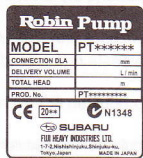

① 	② 	③ 	④ <div style="border: 1px solid black; padding: 5px; display: inline-block;">           PUMP            *****         </div>
--	--	--	---

**EC- DECLARATION OF CONFORMITY  
EG-KONFORMITÄTSERKLÄRUNG  
DÉCLARATION DE CONFORMITÉ "EC"  
EU VERKLARING VAN CONFORMITEIT  
DICHIARAZIONE DI CONFORMITÀ EC  
ΔΗΛΩΣΗ ΣΥΜΜΟΡΦΩΣΗΣ Ε.Ε.**

**DECLARACIÓN DE CONFORMIDAD DE LA CE  
CE-DECLARAÇÃO DE CONFORMIDADE  
EG-FÖRSÄKRAN OM ÖVERENSTÄMMELSE  
EC-YHDENMUKAISUUSSELVITYS  
EC-KONFORMITETS DEKLARASJON  
EU-DEKLARATION OM KONFORMITET**

Manufacturer	Fabricante	FUJI HEAVY INDUSTRIES LTD.
Hersteller	Fabricante	1-7-2, Nishishinjuku, Shinjuku-ku,
Fabricant	Tillverkare	Tokyo 160-8316
Fabrikant	Valmistaja	Japan
Costruttore	Produsent	
Κατασκευαστής	Fabrikant	

Name and address of the person who keeps the Technical Documentation	FUJI HEAVY INDUSTRIES LTD
Name und Anschrift der Person, die für technische Dokumentation verantwortlich ist	Industrial Products Company
Nom et adresse de la personne qui garde la Documentation Technique	Saitama Plant
Naam en adres van de degene bij wie de Technische Documentatie berust	4-410 Asahi, Kitamoto City,
Nome e indirizzo della persona che conserva la documentazione tecnica	Saitama 364-8511
Όνομα και διεύθυνση υπευθύνου για τις Τεχνικές Τεκμηριώσεις	Japan
Nombre y dirección del encargado de la documentación técnica	K. Kato Manager, Quality Control
Nome e endereço do responsável pela conservação da Documentação Técnica	
Namn och adress gällande den juridiska person som förvarar den tekniska dokumentationen	
Sen tahon nimi ja osoite, jonka hallussa teknillinen dokumentaatio on	
Navn og adresse på personen som står for teknisk dokumentasjon	
Navn og adresse på den person, der opbevarer den tekniske dokumentation	

Authorized Compiler In The Community	Compilador autorizado en la Comunidad	Robin Europe GmbH
Autorisiertes Montageunternehmen im Gebiet	Compilador autorizado na comunidade	Willicher Damm 135-137 D-41066
Compilateur autorisé dans la Communauté	Auktoriserad sammansätllare inom gemenskapen	Mönchengladbach
Erkende vertegenwoordiger in het rayon	Paikallinen edustaja	Germany
Compilatore autorizzato nella comunità	Autorisert kompilator i EU	Yoshimitsu Tateno
Εγκριμένος από την Κοινότητα μεταλλωπιστής	Autoriseret computer i samfundet	

Description of the equipment	Beschrijving van de apparatuur	Descripción del equipo	Laitteiston kuvaus
Beschreibung des Geräts	Descrizione dell'apparecchiatura	Descrição do equipamento	Beskrivelse av utstyret
Description de l'équipement	Περιγραφή μηχανήματος	Beskrivning av utrustningen	Beskrivelse af udstyret

Product	:Water Pump	Trade name	ROBIN PTD306	ROBIN PTX220ST
Produkt	:Wasserpumpe	Handelsbezeichnung	ROBIN PTD406	ROBIN PTX320ST
Produit	:Pompe à eau	Marque déposée	ROBIN PTD206T	ROBIN PTX201T
Product	:Waterpomp	Handelsnaam	ROBIN PTD306T	ROBIN PTX301T
Prodotto	:Pompa acqua	Denominazione commerciale	ROBIN PTD405T	ROBIN PTX201H
Προϊόν	:Αντλία Νερού	Εμπορικό Όνομα	ROBIN PTX201	ROBIN PTX201D
Producto	:Bomba de agua	Nombre comercial	ROBIN PTX301	ROBIN PTX301D
Produto	:Bomba Hidráulica	Nome comercial	ROBIN PTX401	ROBIN PTV101
Produkt	:Vattenspump	Handelsnamn	ROBIN PTX220	ROBIN PTV110
Tuote	:Vesipumppu	Kauppanimi	ROBIN PTX320	ROBIN PTV406T
Produkt	:Vannpumpe	Handelsnavn	ROBIN PTX201ST	
Produkt	:Vandpumpe	Handelsbetegnelse	ROBIN PTX301ST	

The undersigned, Y. Takeda, representing the manufacture, herewith declares that the product in conformity with the provisions the following EC-directives;

Der Unterzeichnende, Y. Takeda, den Hersteller repräsentierend, erklärt hiermit, daß das Produkt mit den Forderungen der folgenden EG-Amtsblattsverfügungen übereinstimmt:

Le soussigné, Y. Takeda, représentant le Fabricant, déclare que le produit est en conformité avec les Directives EC suivantes:

Ondergetekende, Y. Takeda, in zijn hoedanigheid als vertegenwoordiger van de fabrikant, verklaart hierbij dat het product voldoet aan de eisen zoals geformuleerd in de volgende EU richtlijnen

Il sottoscritto Y. Takeda, in rappresentanza del costruttore con il presente documento dichiara che il prodotto è conforme alle norme delle seguenti direttive EC:

Ο υπογράφων, Y. Takeda, αντιπρόσωπος του κατασκευαστή, μετά της παρούσης δηλώνει ότι το προϊόν αυτό ανταποκρίνεται με τους κανονισμούς των ακόλουθων οδηγιών της Ε.Ε.:

EL firmante, Y. Takeda, representando al fabricante, declara que el producto conforma las provisiones de las siguientes normativas de la CE:

O abaixo assinado, Y. Takeda, representando o fabricante, declara por meio desta que o produto está em conformidade com as disposições das seguintes directivas da CE:

Undertecknad, Y. Takeda, representerande tillverkaren, försäkras härmed att produkten är i överensstämmelse med bestämmelserna i följande EG-direktiv:

Allekirjoittanut, Y. Takeda, joka edustaa tuotetta, täten ilmoittaa, että tuote on yhdenmukainen seuraavien EC-direktiivien sopimusehtojen kanssa;

Undertegnede og representant for produsenten, Y. Takeda, erklærer herved at produktet er i samsvar med bestemmelserne i følgende EC-direktiver;

Undertegnede, Y. Takeda, der repræsenterer fabrikanten, erklærer hermed, at produktet er i overensstemmelse med de bestemmelser, der findes i følgende EU-direktiver:

References Zur Bezugnahme Références	Referentias Riferimenti Αναφορές	Referencias Referências Referenser	Viitteet Referanser Referencer			
2004/108/EC						
2006/42/EC (98/37/EC)						
2000/14/EC						
Measured Sound Power Level Gemessener Schalldruckpegel Niveau de puissance acoustique mesurée Gemeten geluidsdrukkniveau Livello di rumore misurato Μετρηθέν Επίπεδο Ισχύος Ηχητικών Εκπομπών	Nivel de potencia sonora medido Nível de potência sonora medido Uppmätt bullernivå Mitattu äänivoimataso Målt lydeffektivité Μάτ lydeffektivité		PTD306 PTD406 PTD206T PTD306T PTD405T PTX201 PTX301 PTX401 PTX220 PTX320 PTX201ST PTX301ST	108.1 dB 108.8 dB 108.1 dB 108.9 dB 108.6 dB 100.9 dB 103.8 dB 104.8 dB 100.0 dB 102.7 dB 100.9 dB 103.8 dB	PTX220ST PTX320ST PTX201T PTX301T PTX201H PTX201D PTX301D PTV101 PTV110 PTV406T	100.9 dB 103.8 dB 101.6 dB 104.4 dB 103.9 dB 98.2 dB 99.0 dB 99.8 dB 103.1 dB 105.5 dB
Guaranteed Sound Power level: Garantierter Schalldruckpegel: Niveau de puissance acoustique garantie: Opgegeven geluidsdrukkniveau: Livello di rumore garantito: Εγγυημένο Επίπεδο Ισχύος Ηχητικών Εκπομπών:	Nivel de potencia sonora garantizado: Nível de potência sonora garantido: Garanterad bullernivå: Taattu äänivoimataso: Garantert lydeffektivité: Garanteret lydeffektivité:		PTD306 PTD406 PTD206T PTD306T PTD405T PTX201 PTX301 PTX401 PTX220 PTX320 PTX201ST PTX301ST	110 dB 110 dB 110 dB 110 dB 110 dB 103 dB 105 dB 106 dB 101 dB 103 dB 103 dB 105 dB	PTX220ST PTX320ST PTX201T PTX301T PTX201H PTX201D PTX301D PTV101 PTV110 PTV406T	103 dB 105 dB 103 dB 106 dB 106 dB 100 dB 101 dB 100 dB 105 dB 107 dB
Conformity Assessment Procedure Bewertungsverfahren zur Feststellung der Übereinstimmung Procédé d'évaluation de conformité Toetsprocedure conformiteit Procedura di valutazione di conformità Διαδικασία εκτίμησης ανταπόκρισης	Procedimiento de evaluación de conformidad Procedimento de avaliação da conformidade Procedur för bedömning av överensstämmelse Yhdenmukaisuuden arviointimenetelmä Prosedyre for konformitetsvurdering Procedure anvendt ved bedømmelse af konformitet		Annex V procedure			

Reference to harmonized standards: Verweis auf harmonisierte Normen: Référence pour harmoniser les normes: Referentie aan geharmoniseerde standaarden: Riferimento alle normative armonizzate: Αναφορά στα εναρμονισμένα πρότυπα:	Referencia a normas relacionadas: Referência para harmonizar standards: Hänvisning till harmoniserade standarder: Lähdeviitaukset standardien saamiseksi sopusointuun: Referanse til samstemmende standarder: Reference til harmoniseringsstandarder:	EN809 EN55012 ISO 3744 CISPR 12
--	--	--

Other national standards or specifications used:  
Andere angewandte nationale Normen oder Spezifikationen:  
Autres normes nationales ou spécifications utilisées:  
Overige gebruikte nationale standaarden of specificaties:  
Altre normative nazionali o specifiche impiegate:  
Άλλα κρατικά πρότυπα ή προδιαγραφές που χρησιμοποιήθηκαν:  
Otras normas nacionales o especificaciones utilizadas:  
Outros padrões ou especificações nacionais utilizados:  
Övriga använda nationella standarder eller tekniska specifikationer:  
Muut käytetyt kansalliset standardit tai tekniset tiedot:  
Andre anvendte standarder eller spesifikasjoner:  
Andre anvendte nationale standarder eller specifikationer:

Signature : 

Y. Takeda			
Done at:	Kitamoto, JAPAN	Date:	September. 30. 2009
Ort:	Kitamoto, JAPAN	Datum:	30. September 2009
Fait à:	Kitamoto, JAPAN	Date:	30 septembre 2009
Plaats:	Kitamoto, JAPAN	Datum:	30 september 2009
Firma:	Kitamoto, JAPAN	Preparato a:	30 settembre 2009
Δημιουργήθηκε:	Kitamoto, JAPAN	Ημερομηνία:	30 Σεπτεμβρίου 2009
Hecho en:	Kitamoto, JAPAN	Fecha:	30 septiembre, 2009
Preparado em:	Kitamoto, JAPAN	Data:	30 de Setembro de 2009
Ort:	Kitamoto, JAPAN	Datum:	30 september 2009
Allekirjoituspaikka:	Kitamoto, JAPAN	Päivämäärä:	30. syyskuu. 2009
Utført den:	Kitamoto, JAPAN	Dato:	30. september, 2009
Udført:	Kitamoto, JAPAN	Dato:	30. september 2009
			General Manager, Quality Assurance Generaldirektor, Qualitätssicherung Directeur general, Assurance de la qualité Hoofddirecteur, Kwaliteitsbewaking Direttore generale, Assicurazione Qualità Γενικός διευθυντής, Εξασφάλιση Ποιότητας Director general, Seguro de calidad Director geral, Garantia de Qualidade General Direktör, kvalitetsövervakning Yleinen manageri, Laatuvarkuutus General bestyrer, kvalitetssikring General bestyrer, kvalitetssikring

## FOREWORD

Thank you very much for purchasing a **ROBIN PUMP**.

This manual covers operation and maintenance of **ROBIN PUMP**.

All information in this publication is based on the latest product information available at the time of approval for printing. Please read this manual carefully before operating.

Please take a moment to familiarize yourself with the proper operation and maintenance procedures in order to maximize the safe and efficient use of this product.

Keep this owner's manual at hand, so that you can refer to it at any time.

Due to constant efforts to improve our products, certain procedures and specifications are subjected to change without notice.

When ordering spare parts, always give us the **MODEL, PRODUCTION NUMBER and SERIAL NUMBER** of your product.

EN

Please fill in the following blanks after checking the production number on your product.

(Location of label is different depending on the product specification.)

<div style="text-align: center; border-bottom: 1px solid black; margin-bottom: 5px;">PROD No.</div> <table border="1" style="width: 100%; height: 20px; border-collapse: collapse;"> <tr> <td style="width: 10%;"></td><td style="width: 10%;"></td><td style="width: 10%;"></td><td style="width: 10%;"></td><td style="width: 10%;"></td><td style="width: 10%;"></td><td style="width: 10%;"></td><td style="width: 10%;"></td><td style="width: 10%;"></td><td style="width: 10%;"></td><td style="width: 10%;"></td> </tr> </table>												<div style="text-align: center; border-bottom: 1px solid black; margin-bottom: 5px;">SER No.</div> <table border="1" style="width: 100%; height: 20px; border-collapse: collapse;"> <tr> <td style="width: 10%;"></td><td style="width: 10%;"></td><td style="width: 10%;"></td><td style="width: 10%;"></td><td style="width: 10%;"></td><td style="width: 10%;"></td><td style="width: 10%;"></td><td style="width: 10%;"></td><td style="width: 10%;"></td><td style="width: 10%;"></td> </tr> </table>										

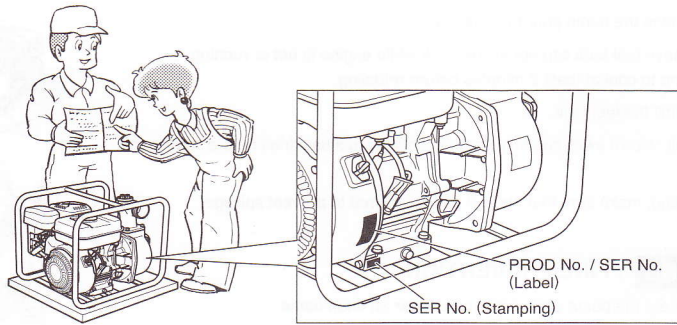

## CONTENTS

	Page
1. SAFETY PRECAUTIONS .....	2
2. COMPONENTS .....	4
3. PRE-OPERATION FOR STARTING .....	6
4. OPERATING YOUR PUMP .....	7
5. MAINTENANCE .....	7
6. PREPARATIONS FOR STORAGE .....	10
7. OIL SENSOR INSTRUCTIONS .....	10
8. EASY TROUBLESHOOTING .....	11
9. SPECIFICATIONS .....	12

**NOTE** Please refer to the illustrations on the back page of the front cover or back cover for Fig. ① to ⑧ indicated in the sentence.



# 1. SAFETY PRECAUTIONS

Please make sure you review each precaution carefully.  
Pay special attention to statement preceded by the following words.

**⚠ WARNING** "WARNING" indicates a strong possibility of severe personal injury or loss of life if instructions are not followed.

**⚠ CAUTION** "CAUTION" indicates a possibility of personal injury or equipment damage if instructions are not followed.

## **⚠ WARNING** : EXHAUST PRECAUTIONS

- Never inhale exhaust gasses.  
They contain carbon monoxide, a colorless, odorless and extremely dangerous gas which can cause unconsciousness or death.
- Never operate the pump indoors or in a poorly ventilated area, such as tunnel, cave, etc.
- Exercise extreme care when operating the pump near people or animals.
- Keep the exhaust pipe free of foreign objects.

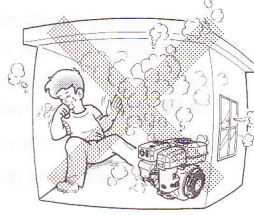

## **⚠ WARNING** : REFUELING PRECAUTIONS

- Gasoline is extremely flammable and its vapors can explode if ignited.
- Do not refuel indoors or in a poorly ventilated area.
- Be sure to stop the pump prior to refueling.
- Do not remove fuel tank cap nor fill fuel tank while engine is hot or running.  
Allow engine to cool at least 2 minutes before refueling.
- Do not overfill the fuel tank.
- If fuel is spilt, wipe it away carefully and wait until the fuel has dried before starting the engine.
- After refueling, make sure that the fuel cap is secured to prevent spillage.

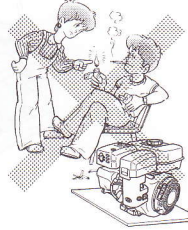
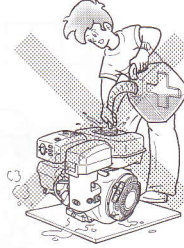

## **⚠ WARNING** : FIRE PREVENTION

- Do not operate the pump while smoking or near an open flame.
- Do not use around dry brush, twigs, cloth rags, or other flammable materials.
- Keep cooling air intake (recoil starter area) and muffler side of the engine at least 1 meter (3 feet) away from buildings, obstructions and other burnable objects.
- Keep the pump away from flammables and other hazardous materials (trash, rags, lubricants, explosives).

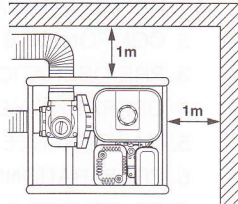

## **⚠ WARNING** : OTHER SAFETY PRECAUTIONS

- Be careful of hot parts.  
The muffler and other engine parts become very hot while the pump is running or just after it has stopped. Operate the pump in a safe area and keep children away from the running pump.
- Do not use diaphragm pump for the mixture of water and oil.

NOTE: Please refer to the illustrations on the back page of the front cover or back cover for Fig. (1) to (6) indicated in the sentence.

- Do not touch the spark plug and ignition cable when starting and operating the engine.
- Operate the pump on a stable, level surface.  
If the engine is tilted, fuel spillage may result.

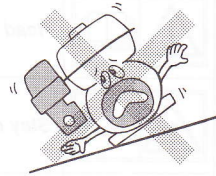

**NOTE**

Operating the pump at a steep incline may cause seizure due to improper lubrication even with a maximum oil level.

- Do not transport the pump with fuel in tank or with fuel strainer cock open.
- Keep the unit dry (do not operate it in rainy conditions).



EN

**⚠ CAUTION : PRE-OPERATION CHECKS**

- Carefully check fuel hoses and joints for looseness and fuel leakage. Leaked fuel creates a potentially dangerous situation.
- Check bolts and nuts for looseness. A loose bolt or nut may cause serious engine trouble.
- Check the engine oil and refill if necessary.
- Check the fuel level and refill if necessary. Take care not to overfill the tank.
- Keep cylinder fins and recoil starter free of dirt, grass and other debris.
- Wear snug fitting working clothes when operating the engine.  
Loose aprons, towels, belt, etc., may be caught in the engine or drive train, causing a dangerous situation.



## SYMBOLS

	Read manual.		Shut off fuel valve when the engine is not in use.
	Stay clear of the hot surface.		Check for leakage from hose and fittings.
	Exhaust gas is poisonous. Do not operate in an unventilated room or enclosed area.		Fire, open flame and smoking prohibited.
	Stop the engine before refueling.		HOT, avoid touching the hot area.

	On (Run)		Engine start (Electric start)		Fuel (gasoline)		Primer
○	Off (Stop)		Engine stop		Fuel (diesel)		Push primer
	Engine oil		Cold engine		Fuel shut-off		Do not push primer
	Add oil		Warm engine		Fuel system failure / malfunction	2X	Two times
	Battery		Electrical preheat (Low temperature start aid)		Choke		
	Fast		Run position	+	Plus ; positive polarity		
	Slow		Stop position	-	Minus ; negative polarity		

## 2. COMPONENTS

(See Fig. 1)

**NOTE** Please refer to the illustrations on the back page of the front cover or back cover for Fig. 1 to 8 indicated in the sentence.

CENTRIFUGAL PUMP (PTX201, 301, 401, 201H, 210, 310, 220, 320)

SEMI TRASH PUMP (PTX201ST, 301ST, 210ST, 310ST, 220ST, 320ST)

(See Fig. 1-1)

- |                               |                              |   |
|-------------------------------|------------------------------|---|
| ① Plug (drain)                | ⑨ Fuel tank                  | ⑰ Air cleaner                               |
| ② Suction                     | ⑩ Casing cover               | ⑱ Speed control lever                       |
| ③ Delivery                    | ⑪ Drain plug (at two places) | ⑲ Strainer                                  |
| ④ Frame                       | ⑫ Stop Switch                | ⑳ Hose coupling                             |
| ⑤ Plug (priming)              | ⑬ Recoil starter             | ㉑ Hose band                                 |
| ⑥ Muffler                     | ⑭ Recoil Starter handle      | ㉒ Tools                                     |
| ⑦ Spark plug                  | ⑮ Fuel cock                  | ㉓ Instruction for use<br>(This publication) |
| ⑧ Oil filler (with oil gauge) | ⑯ Choke lever                |   |

## TRASH PUMP (PTX201T, 301T)

(See Fig. ①-②)

- |                              |                               |   |
|------------------------------|-------------------------------|---|
| ① Plug (drain)               | ⑪ Fuel tank                   | ⑳ Strainer                                  |
| ② Casing                     | ⑫ Delivery                    | ㉑ Hose coupling                             |
| ③ Suction                    | ⑬ Knob                        | ㉒ Hose band                                 |
| ④ Frame                      | ⑭ Oil filler (with oil guage) | ㉓ Tools                                     |
| ⑤ Plug (priming)             | ⑮ Stop switch                 | ㉔ Instruction for use<br>(This publication) |
| ⑥ Muffler                    | ⑯ Recoil Starter              |   |
| ⑦ Air cleaner                | ⑰ Recoil Starter handle       |   |
| ⑧ Spark plug                 | ⑱ Fuel cock                   |   |
| ⑨ Drain plug (at two places) | ㉀ Chocke lever                |   |
| ⑩ Casing cover               | ㉁ Speed control lever         |   |

EN

## DIAPHRAGM PUMP (PTX201D, 301D)

(See Fig. ①-③)

- |                               |                         |   |
|-------------------------------|-------------------------|---|
| ① Oil filler (with Oil guage) | ⑪ Recoil starter        | ㉑ Tools                                     |
| ② Pump body                   | ⑫ Recoil starter handle | ㉒ Instruction for use<br>(This publication) |
| ③ Gear case                   | ⑬ Fuel cock             |   |
| ④ Fuel tank                   | ⑭ Choke lever           |   |
| ⑤ Muffler                     | ⑮ Speed control lever   |   |
| ⑥ Air cleaner                 | ⑯ Plug (filler)         |   |
| ⑦ Spark plug                  | ⑰ Suction chamber       |   |
| ⑧ Drain plug (at two places)  | ⑱ Suction               |   |
| ⑨ Delivery                    | ㉀ Check valves          |   |
| ⑩ Stop switch                 | ㉁ Strainer              |   |

### 3. PRE-OPERATION FOR STARTING

(See Fig. 2)

#### 1. ATTACH THE FLANGE AND CHECK VALVES

(PTX201D, 301D Only See Fig. 2-1)

Attach the suction flange, delivery flange and check valves to the pump when operating the brand new pump for the first time.

- ① Check valves
- ② Delivery
- ③ Suction

#### ⚠ CAUTION

Be careful not to overtighten the bolts.  
Suction flange tightening torque : 90-120 kg-cm  
Delivery flange tightening torque : 90-120 kg-cm

#### 2. CONNECT SUCTION HOSE

(See Fig. 2-2)

Use a reinforced-wall or wire braided hose to prevent suction collapse.

Since the pump self-priming time is directly proportional to hose length, a short hose is recommended.

#### ⚠ CAUTION

Always use a strainer with the suction hose. Gravel or debris sucked into the pump will cause serious damage to the impeller and the pump casting.

#### 3. CONNECT DELIVERY HOSE

(See Fig. 2-3)

When using a fabric hose, always use a hose band to prevent the hose from disconnecting under high pressure.

#### 4. CHECK ENGINE OIL (See Fig. 2-5)

Before checking or refilling engine oil, be sure the engine is located on stable, level surface and stopped.

- Do not screw the oil gauge into the oil filler neck to check oil level. If the oil level is low, refill to the upper level with the following recommended oil.
- Use 4-stroke automotive detergent oil of API service class SE or higher grade (SG, SH or SJ is recommended).
- Select the viscosity based on the air temperature at the time of operation as shown in the table. (See Fig. 2-4)

Explanation of Fig. 2-5

- ① Oil Gauge
- ② Upper Level
- ③ Lower Level

Model	Oil capacity
PTX201, PTX301, PTX201H, PTX201ST, PTX301ST, PTX201T, PTX201D, PTX301D, PTX210, PTX310, PTX220, PTX320, PTX210ST, PTX310ST, PTX220ST, PTX320ST	0.6L
PTX401, PTX301T	1.0L

#### 5. CHECK FUEL

(See Fig. 2-6)

#### ⚠ WARNING

Do not refuel while smoking, near an open flame or other such potential fire hazards. Otherwise fire accident may occur.

- Stop the engine and open the cap.
- Use automotive unleaded gasoline only.  
This engine is certified to operate on automotive unleaded gasoline.  
Fuel Tank Capacity  
Refer to "9. SPECIFICATIONS" Page 12 for fuel tank capacity
- Close the fuel cock before filling the fuel tank.
- Do not fill above the top of the fuel filter screen (marked ②), or the fuel may overflow when it heats up later and expands.
- When filling the fuel tank, always use the fuel filter screen.
- Wipe off any spilled fuel before starting the engine. (See Fig. 2-7)

#### 6. CHECK PRIMING WATER

(See Fig. 2-8)

It is recommended that the water chamber of pump casing should be primed with full of water before operating.

#### ⚠ WARNING

Never attempt to operate the pump without priming water or the pump will overheat. Extended dry operation will destroy the mechanical seal.

If the unit has been operated dry, stop the engine immediately and allow the pump to cool before adding priming water.

## 4. OPERATING YOUR PUMP

### 1. STARTING (See Fig. ③)

- (1) Open the fuel cock. (See Fig. ③-①)
- (2) Turn the STOP SWITCH to the position "I" (ON). (See Fig. ③-②)
- (3) Set the speed control lever 1/3 of the way towards the high speed position. (See Fig. ③-③)
- (4) Close the choke lever. (See Fig. ③-④)
  - If the engine is cold or the ambient temperature is low, close the choke lever fully.
  - If the engine is warm or the ambient temperature is high, open the choke lever half-way, or keep it fully open.
- (5) Pull the starter handle slowly until resistance is felt. This is the "compression" point. Return the handle to its original position and pull swiftly. Do not pull out the rope all the way. After starting the engine, allow the starter handle to return to its original position while still holding the handle. (See Fig. ③-⑤)
- (6) After starting the engine, gradually open choke by turning the choke lever and finally keep it fully opened. Do not fully open the choke lever immediately when the engine is cold or the ambient temperature is low, because the engine may stop. (See Fig. ③-⑥)

### 2. RUNNING (See Fig. ④)

- (1) After the engine starts, set the speed control lever at the low speed position (L) and warm it up without load for a few minutes. (See Fig. ④-①)
- (2) Gradually move the speed control lever toward the high speed position (H) and set it at the required engine speed. (See Fig. ④-②)
  - Whenever high speed operation is not required, slow the engine down (idle) by moving the speed control lever to save fuel and extend engine life.

### 3. STOPPING (See Fig. ⑤)

- (1) Set the speed control lever at the low speed position and allow the engine to run at low speed for 1 or 2 minutes before stopping. (See Fig. ⑤-①)
- (2) Turn the STOP SWITCH counterclockwise to the position "O" (OFF). (See Fig. ⑤-②)
- (3) Close the fuel cock. (See Fig. ⑤-③)
- (4) Pull the starter handle slowly and return the handle to its original position when resistance is felt. This operation is necessary to prevent outside moist air from intruding into the combustion chamber. (See Fig. ⑤-④)

### ※ STOPPING ENGINE WITH THE FUEL COCK

Close the fuel cock and wait for a while until the engine stops. Avoid to let the fuel remain in the carburator over long periods, or the passages of the carburator may become clogged with impurities, and malfunctions may result.

## 5. MAINTENANCE

### (See Fig. ⑥)

#### 1. DAILY INSPECTION

Before running the engine, check the following service items.

- ① Loose or broken bolts and nuts
- ② Clean air cleaner element
- ③ Enough clean engine oil
- ④ Leakage of gasoline and engine oil
- ⑤ Enough gasoline
- ⑥ Safe surroundings
- ⑦ Check the priming water
- ⑧ Excessive vibration, noise

EN

## 2. PERIODIC INSPECTION

Periodic maintenance is vital to the safe and efficient operation of your product.

Check the table below for periodic maintenance intervals. The below chart is based on the normal product operation schedule.

### ⚠ CAUTION

Replace rubber pipes for fuel passage every two years. If fuel leakage is found, replace the pipe immediately.

Periodic Maintenance Schedule table

Maintenance items	Every 8 hours (Daily)	Every 50 hours (Weekly)	Every 200 hours (Monthly)	Every 300 hours	Every 500 hours	Every 1000 hours
CLEAN PUMP SET AND CHECK BOLTS AND NUTS	● (Daily)					
CHECK AND REFILL ENGINE OIL	● (Refill daily up to upper level.)					
CHANGE ENGINE OIL	(Initial 20 hours)	●				
CLEAN SPARK PLUG		●				
CLEAN AIR CLEANER		●				
LUBRICATE THE PUMP-ROD BEARING (PTX201D,301D only)		●				
REMOVE THE PUMP CASING AND CLEAN (Except PTX201D,301D)			●			
CLEAN FUEL STRAINER			●			
CLEAN AND ADJUST SPARK PLUG AND ELECTRODES			●			
CHECK AND ADJUST VALVE CLEARANCE				●		
REMOVE CARBON FROM CYLINDER HEAD					●	
CLEAN AND ADJUST CARBURETOR					●	
CHECK AND REFILL GEAR BOX GREASE (PTX201D,301D only)					●	
CHECK SUCTION AND DELIVERY CHECK VALVES (PTX201D,301D only)					●	
OVERHAUL ENGINE IF NECESSARY						●

## 3. INSPECTING THE SPARK PLUG

(See Fig. 7-①)

(1) Clean off carbon deposits on the spark plug electrode using a plug cleaner or wire brush.

(2) Check electrode gap. The gap should be 0.6 mm to 0.7 mm.

Adjust the gap, if necessary, by carefully bending the side electrode.

**Recommended Spark Plug : NGK BR-6HS**

#### 4. ENGINE OIL CHANGE (See Fig. 7-2,3)

Initial oil change : After 20 hours of operation  
Thereafter : Every 100 hours of operation

- (1) When changing oil, stop the engine and loosen the drain plug. Drain the used oil while the engine is warm. Warm oil drains quickly and completely.

#### ⚠ CAUTION

To prevent injury, pay attention to the hot oil. Make sure the fuel cap is tightly secured to avoid spillage.

- (2) Re-install the drain plug before refilling oil.

Model	Oil capacity
PTX201, PTX301, PTX201H, PTX201ST, PTX301ST, PTX201T, PTX201D, PTX301D, PTX210, PTX310, PTX220, PTX320, PTX210ST, PTX310ST, PTX220ST, PTX320ST	0.6L
PTX401, PTX301T	1.0L

- (3) Refer to page 6 for the recommended oil.

- Always use the best grade and clean oil. Contaminated oil, poor quality oil and shortage of oil cause damage to engine or shorten the engine life.

#### 5. CLEANING FUEL CUP (See Fig. 7-4)

⚠ WARNING Flame Prohibited

- (1) Inspect fuel cup for water and dirt. (See Fig. 7-4-1)
- (2) To remove water and dirt, close the fuel cock and remove the fuel cup.
- (3) After removing dirt and water, wash the fuel cup with kerosene or gasoline. Reinstall securely to prevent leakage.

#### 6. CLEANING AIR CLEANER

(See Fig. 7-5,6)

A dirty air cleaner element will cause starting difficulty, power loss, engine malfunctions, and shorten engine life extremely. Always keep the air cleaner element clean.

⚠ WARNING Flame Prohibited

- (1) Urethane Foam Element Type (See Fig. 7-5)

- Remove the element and wash it in kerosene or diesel fuel. Then saturate it in a mixture of 3 parts kerosene or diesel fuel and 1 part engine oil. Squeeze the element to remove the mixture and install it in the air cleaner.

- (2) Urethane Foam Dual Element Type (See Fig. 7-6)

- Urethane Foam cleaning (See Fig. 7-6-2)  
Wash and clean the urethane foam with detergent. After cleaning, dry it. Clean the urethane foam element every 50 hours.
- Second element (See Fig. 7-6-1)  
Clean by tapping gently to remove dirt and blow off dust. Never use oil. Clean the paper element every 50 hours of operation, and replace element set every 200 hours.

Clean and replace air cleaner elements more often when operating in dusty environments.

#### 7. FUEL HOSE REPLACEMENT (See Fig. 7-7)

#### ⚠ WARNING

Take extreme caution when replacing fuel hose ; gasoline is extremely flammable.

Replace the fuel hose every 1,000 hours or every year. If fuel leaks from fuel hose, replace the fuel hose immediately.

#### 8. CHECKING BOLTS, NUTS AND SCREWS

- Retighten loose bolts and nuts.
- Check for fuel and oil leaks.
- Replace damaged parts with new ones.

#### 9. CLEANING PUMP INSIDE

- Turn the knob counterclockwise and open the casing cover holder.
- Pull the casing toward you, and then remove the casing and the inner casing.
- Clean the inside of pump casing and casing cover with clean water.

EN



## 6. PREPARATIONS FOR STORAGE

### 1. WATER (See Fig. 8-1)

(Except PTX201D, 301D)

Drain all water from the drain plug.

#### **CAUTION**

When retightening drain plug, be sure to clean the drain plug and the thread of casing. Otherwise, the thread may be damaged.

### 2. DISCONNECT THE DELIVERY HOSE

Tilt the pump and drain all water from delivery hole. Severe damage to pump may result if water freezes in the pumping chamber.

### 3. DISCHARGE FUEL (See Fig. 8-3)

#### **WARNING** Flame Prohibited

If you do not use the engine more than 1 month, discharge fuel to prevent gum in the fuel system and carburetor parts.

- Remove the strainer cup, place the strainer over a container and open the strainer cock to discharge fuel from the fuel tank.
- Remove the drain screw of the carburetor float chamber and discharge fuel.

### 4. ENGINE OIL (See Fig. 8-4)

- Change the engine oil with fresh oil.
- Remove the spark plug, pour about 5 cc of engine oil into the cylinder, slowly pull the starter handle of the recoil starter 2 or 3 times, and reinstall the spark plug.

### 5. CLEAN AND STORE

- Slowly pull the recoil starter handle until resistance is felt and leave it in that position.
- Clean the pump thoroughly with an oiled cloth, put the cover on, and store the pump indoors in a well ventilated, low humidity area.

## 7. OIL SENSOR INSTRUCTIONS

(OPTIONAL)

### 1. FUNCTION OF OIL SENSOR

The engine will stop automatically when the oil level falls below the safety limit. The engine cannot be started unless the level is raised above the prescribed limit.

(See Fig. 2-5)

### 2. RESTARTING

- (1) Fill the crankcase with oil up to the proper level.
- (2) As for restarting and operating the engine, refer to section "4. OPERATING YOUR PUMP" on page 7.
  - Check the wire connector from the engine. It must be connected securely to the wire from oil sensor.
  - When selecting the engine oil, refer to page 6 for the recommended oil.

## 8. EASY TROUBLESHOOTING

### 1. PUMP DOES NOT RUN .

- Engine dose not start.  
(See 8.-6 "6. WHEN ENGINE DOES NOT START")
- Sticking of impeller (Except PTX201D, 301D)  
(Disassemble and clean.)
- Solid object preventing pump-rod from completing stroke.  
(PTX201D, 301D only) (Disassemble and clean.)

### 2. PUMPING VOLUME IS SMALL.

- Sucking air at suction side.  
(Check piping at suction side.)
- Drop off engine output  
(Consult your nearest dealer.)
- Breakage of mechanical seal.  
(Except PTX201D, 301D) (Consult your nearest dealer.)
- Debris keeping check valve open.  
(PTX201D, 301D only) (Disassemble and clean.)
- High suction lift (Lower.)
- Suction hose is too long or thin.  
(Use a thick hose in minimum length.)
- Leak of water from water passage. (Stop leaking.)
- Clogging of foreign substance in impeller.  
(Except PTX201D, 301D) (Disassemble and clean.)
- Breakage of rubber diaphragm.  
(Consult your nearest dealer) (PTX201D, 301D only)
- Wear of impeller. (Except PTX201D, 301D)
- Looseness of suction chamber.  
(Retighten) (PTX201D, 301D only)
- Strainer is clogged. (Clean.)
- Engine speed is too low.  
(Consult your nearest dealer.)

### 3. PUMP DOES NOT SELFPRIME.

- Suction of air at suction side.  
(Except PTX201D, 301D) (Check piping at suction side.)
- Insufficient priming water inside pump casing  
(Except PTX201D, 301D) (Prime fully.)
- Imperfect tightening of drain plug.  
(Except PTX201D, 301D)(Tighten the plugs completely.)
- Engine speed is too low.  
(Except PTX201D, 301D) (Consult your nearest dealer.)
- Sucking air from mechanical seal.  
(Except PTX201D, 301D) (Consult your nearest dealer.)

### 4. DELIVERY HOSE DOES NOT STAY ON COUPLING.

- Hose may be kinked or discharge end may be blocked or clogged.  
(PTX201D, 301D only) (Straighten or clean.)

### 5. PUMP SUDDENLY STOPS.

- Solid object preventing pump-rod from completing stroke.  
(PTX201D, 301D only) (Disassemble and clean.)

### 6. WHEN ENGINE DOES NOT START :

Perform the following checks before you take the pump to your Robin dealer. If you still have trouble after completing the checks, take the pump to your nearest Robin dealer.

#### (1) Is there a strong spark across the electrode ?

- Is the stop switch at position " I " (ON)?
- Remove and inspect the spark plug.  
If the electrode is fouled, clean or replace it with new one.
- Remove the spark plug and connect it to the plug cap.  
Pull the starter handle while grounding spark plug against engine body. Try with a new spark plug if the spark is weak or there is no spark.  
The ignition system is faulty if there is no spark with a new spark plug.

EN

#### ⚠ WARNING

- Wipe out spilled fuel carefully before testing.  
Place spark plug as far away from spark plug hole as possible.
- Do not hold spark plug by hand while pulling recoil starter.

#### NOTE

The engine with oil sensor will stop automatically when the oil level falls below the prescribed limit. Unless the oil level is raised above the prescribed limit, the engine will stop immediately after starting.

#### (2) Is there enough compression?

Pull the starter handle slowly and check if resistance is felt. If little force is required to pull the starter handle, check if the spark plug is tightened firmly. If the spark plug is loose, tighten it.

#### (3) Is the spark plug wet with gasoline?

- Is the fuel cock opened?
- Choke (close choke lever) and pull the starter handle five or six times. Remove the plug and check if its electrode is wet. If the electrode is wet, fuel is well supplied to your engine.
- When the electrode is dry, check where the fuel stops.  
(Check the fuel intake of the carburetor.)
- In case the engine does not start with well supplied fuel, try using fresh fuel.

## 9. SPECIFICATIONS

Model		PTX201	PTX301	PTX401	PTX201ST	PTX301ST
PUMP	Type	Self-priming, Centrifugal pump			Self-priming, Semi Trash pump	
	Suction x Delivery Diameters mm	50 x 50	76 x 76	101 x 101	50 x 50	76 x 76
	Total Head m	32		28	23	
	Maximum Delivery Volume Liter / min	520	1000	1800	700	1000
	Suction Head m	8			7.6	
	Axle Seal Material (Mechanical Seal)	Ceramic - carbon			Silicon - carbide	
Model		EX13	EX17	EX27	EX13	EX17
Type		Robin Air - Cooled, 4 - cycle, OHC, Gasoline Engine				
Lubricant		Automotive detergent oil (API / SE or higher grade, SG, SH or SJ is recommended. SEA / 10W-30 etc.				
Oil Capacity Liter		0.6		1.0	0.6	
Fuel		Automotive unleaded gasoline				
Fuel Tank Capacity Liter		2.7	3.6	6.1	2.7	3.6
Spark plug		NGK BR-6HS				
Starting system		Recoil starter				
Dimensions (L x W x H) mm		470x344x414	527x368x417	610x425x565	470x344x414	527x368x417
Net Weight kg		24.9	27.6	44.5	24.9	27.6
Standard accessories		Engine tool kit (1set), Strainer (1pc.), Hose coupling (2set), Hose band (3pcs.)				

Model		PTX201T	PTX301T	PTX201H	PTX201D	PTX301D
PUMP	Type	Self-priming, Trash pump		Self-priming, Centrifugal High Water pump	Self-priming, Diaphragm pump	
	Suction x Delivery Diameters mm	50 x 50	76 x 76	50 x 50		76 x 76
	Total Head m	27	28	50	15	
	Maximum Delivery Volume Liter / min	750	1300	400	125	250
	Suction Head m	8			7.6	
	Axle Seal Material (Mechanical Seal)	Silicon - carbide		Ceramic - carbon	—	
Model		EX17	EX27	EX17	EX13	EX17
Type		Robin Air - Cooled, 4 - cycle, OHC, Gasoline Engine				
Lubricant		Automotive detergent oil (API / SE or higher grade, SG, SH or SJ is recommended. SEA / 10W-30 etc.				
Oil Capacity Liter		0.6	1.0	0.6		
Fuel		Automotive unleaded gasoline				
Fuel Tank Capacity Liter		3.6	6.1	3.6	2.7	3.6
Spark plug		NGK BR-6HS				
Starting system		Recoil starter				
Dimensions (L x W x H) mm		560x436x397	672x484x610	539x368x455	614x370x510	660x420x510
Net Weight kg		34.5	48.5	27.0	38.0	45.0
Standard accessories		Engine tool kit (1set), Strainer (1pc.), Hose coupling (2set), Hose band (3pcs.)				

Model		PTX210	PTX310	PTX210ST	PTX310ST
PUMP	Type	Self-priming, Centrifugal pump		Self-priming, Semi Trash pump	
	Suction x Delivery Diameters mm	50 x 50	76 x 76	50 x 50	76 x 76
	Total Head m	32		23	
	Maximum Delivery Volume Liter / min	520	1000	700	1000
	Suction Head m	8			
	Axle Seal Material (Mechanical Seal)	Ceramic - carbon		Silicon - carbide	
ENGINE	Model	EX16	EX17	EX16	EX17
	Type	Air - Cooled, 4 - cycle, OHC, Gasoline Engine			
	Lubricant	Automotive detergent oil (API / SE or higher grade, SG, SH or SJ is recommended. SEA / 10W-30 etc.)			
	Oil Capacity Liter	0.6			
	Fuel	Automotive unleaded gasoline			
	Fuel Tank Capacity Liter	3.6			
	Spark plug	TORCH E6RC (NGK BR-6HS)			
	Starting system	Recoil starter			
	Dimensions (L x W x H) mm	527x368x417			
Net Weight kg	24.9	26.1	24.9	26.1	
Standard accessories	Engine tool kit (1set), Strainer (1pc.), Hose coupling (2set), Hose band (3pcs.)				

EN

Model		PTX220	PTX320	PTX220ST	PTX320ST
PUMP	Type	Self-priming, Centrifugal pump		Self-priming, Semi Trash pump	
	Suction x Delivery Diameters mm	50 x 50	76 x 76	50 x 50	76 x 76
	Total Head m	32		23	
	Maximum Delivery Volume Liter / min	520	1000	700	1000
	Suction Head m	8			
	Axle Seal Material (Mechanical Seal)	Ceramic - carbon		Silicon - carbide	
ENGINE	Model	EX16	EX17	EX16	EX17
	Type	Air - Cooled, 4 - cycle, OHC, Gasoline Engine			
	Lubricant	Automotive detergent oil (API / SE or higher grade, SG, SH or SJ is recommended. SEA / 10W-30 etc.)			
	Oil Capacity Liter	0.6			
	Fuel	Automotive unleaded gasoline			
	Fuel Tank Capacity Liter	3.6			
	Spark plug	TORCH E6RC (NGK BR-6HS)			
	Starting system	Recoil starter			
	Dimensions (L x W x H) mm	527x368x417			
Net Weight kg	24.9	26.1	24.9	26.1	
Standard accessories	Engine tool kit (1set), Strainer (1pc.), Hose coupling (2set), Hose band (3pcs.)				



SUBARU

STAGE	START	END	ACTIVITY	UNIT	QTY	REMARKS
1	01/01/2010	01/01/2010	Site Preparation	sqm	1000	
2	01/01/2010	01/01/2010	Foundation	sqm	1000	
3	01/01/2010	01/01/2010	Structure	sqm	1000	
4	01/01/2010	01/01/2010	Roofing	sqm	1000	
5	01/01/2010	01/01/2010	Interior Finishing	sqm	1000	
6	01/01/2010	01/01/2010	Exterior Finishing	sqm	1000	
7	01/01/2010	01/01/2010	Site Works	sqm	1000	
8	01/01/2010	01/01/2010	Handover	sqm	1000	

STAGE	START	END	ACTIVITY	UNIT	QTY	REMARKS
1	01/01/2010	01/01/2010	Site Preparation	sqm	1000	
2	01/01/2010	01/01/2010	Foundation	sqm	1000	
3	01/01/2010	01/01/2010	Structure	sqm	1000	
4	01/01/2010	01/01/2010	Roofing	sqm	1000	
5	01/01/2010	01/01/2010	Interior Finishing	sqm	1000	
6	01/01/2010	01/01/2010	Exterior Finishing	sqm	1000	
7	01/01/2010	01/01/2010	Site Works	sqm	1000	
8	01/01/2010	01/01/2010	Handover	sqm	1000	